

Constraining the shape of the Universe using Circle Searches

Standard Cosmology at the
Threshold of Change
Aristotle University of Thessaloniki
June 4, 2024

Deyan MIHAYLOV
Case Western Reserve University
COMPACT Collaboration



Glenn STARKMAN



Craig COPI



Andrius TAMOŠIŪNAS



Amirhossein SAMANDAR



Fernando CORNET-GÓMEZ



Arthur KOSOWSKY



Stefano ANSELMINI



Yashar AKRAMI



Javier Carron DUQUE



Mikel MARTIN



Andrew JAFFE



Thiago PEREIRA



Glenn STARKMAN



Craig COPI



Andrius TAMOŠIŪNAS



Amirhossein SAMANDAR



Fernando CORNET-GÓMEZ



Arthur KOSOWSKY



Stefano ANSELMINI



Yashar AKRAMI



Javier Carron DUQUE



Mikel MARTIN



Andrew JAFFE



Thiago PEREIRA



**What is cosmic topology
and why study it?**



Wait, topology?!

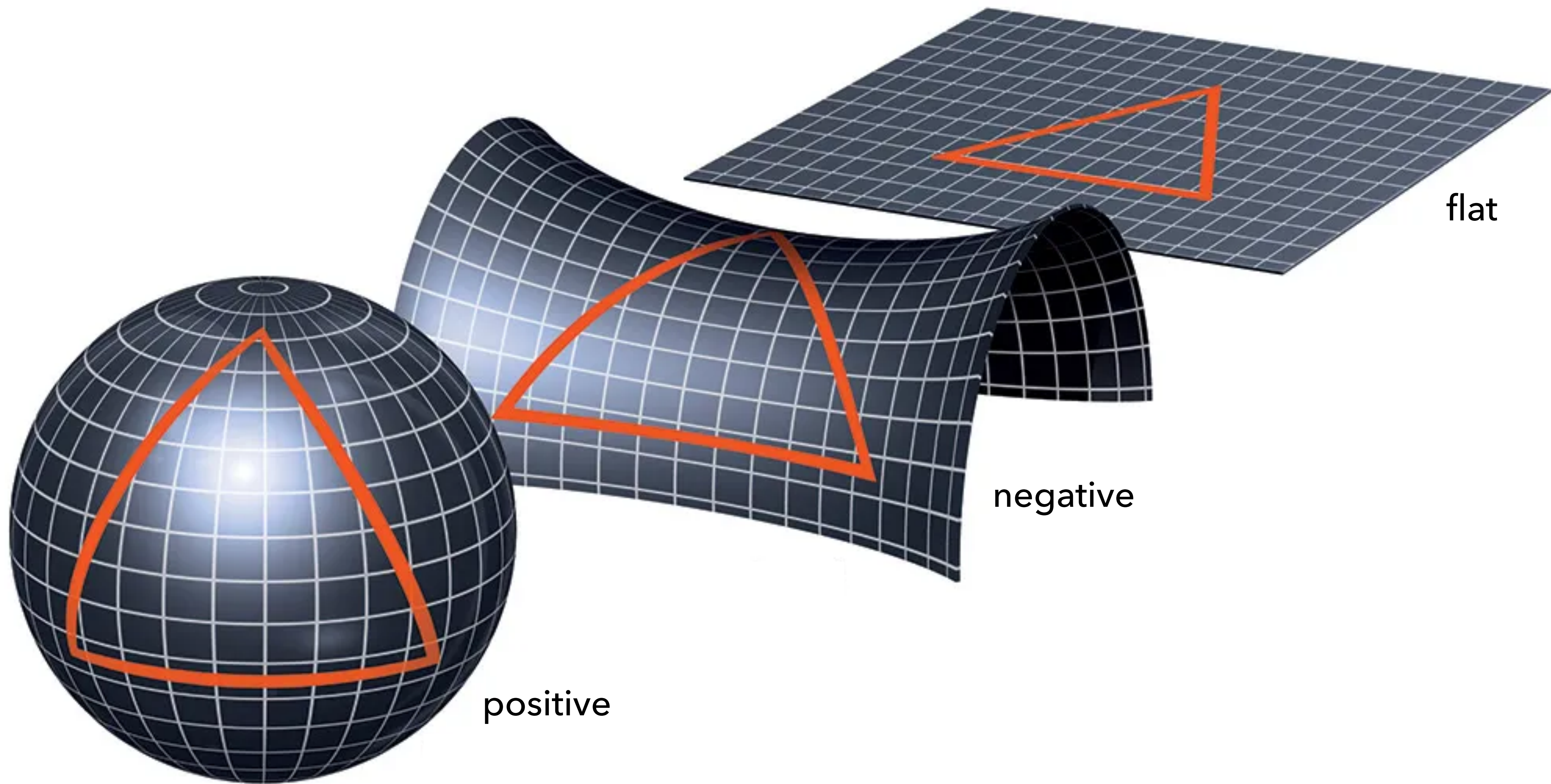

positive

negative

flat



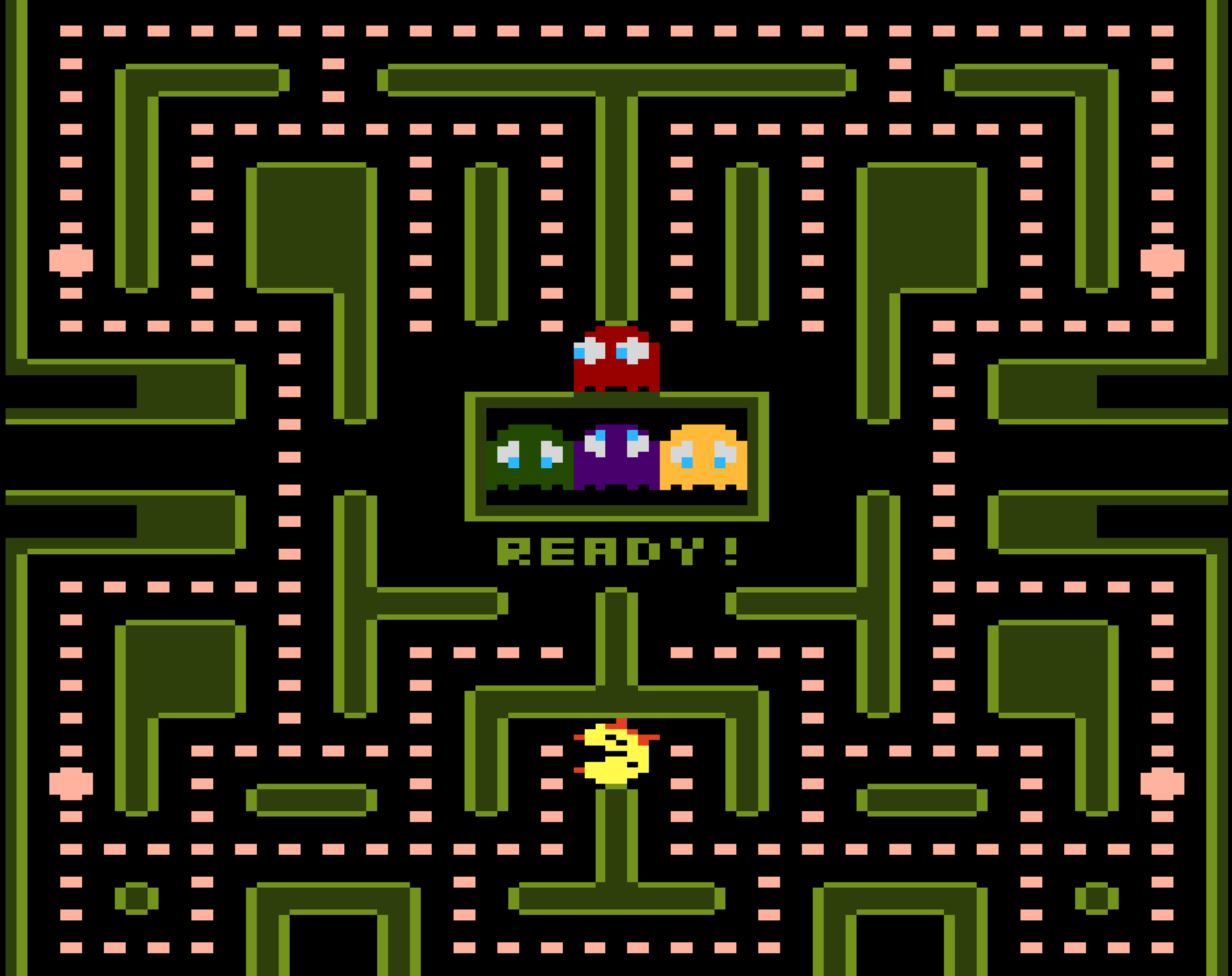

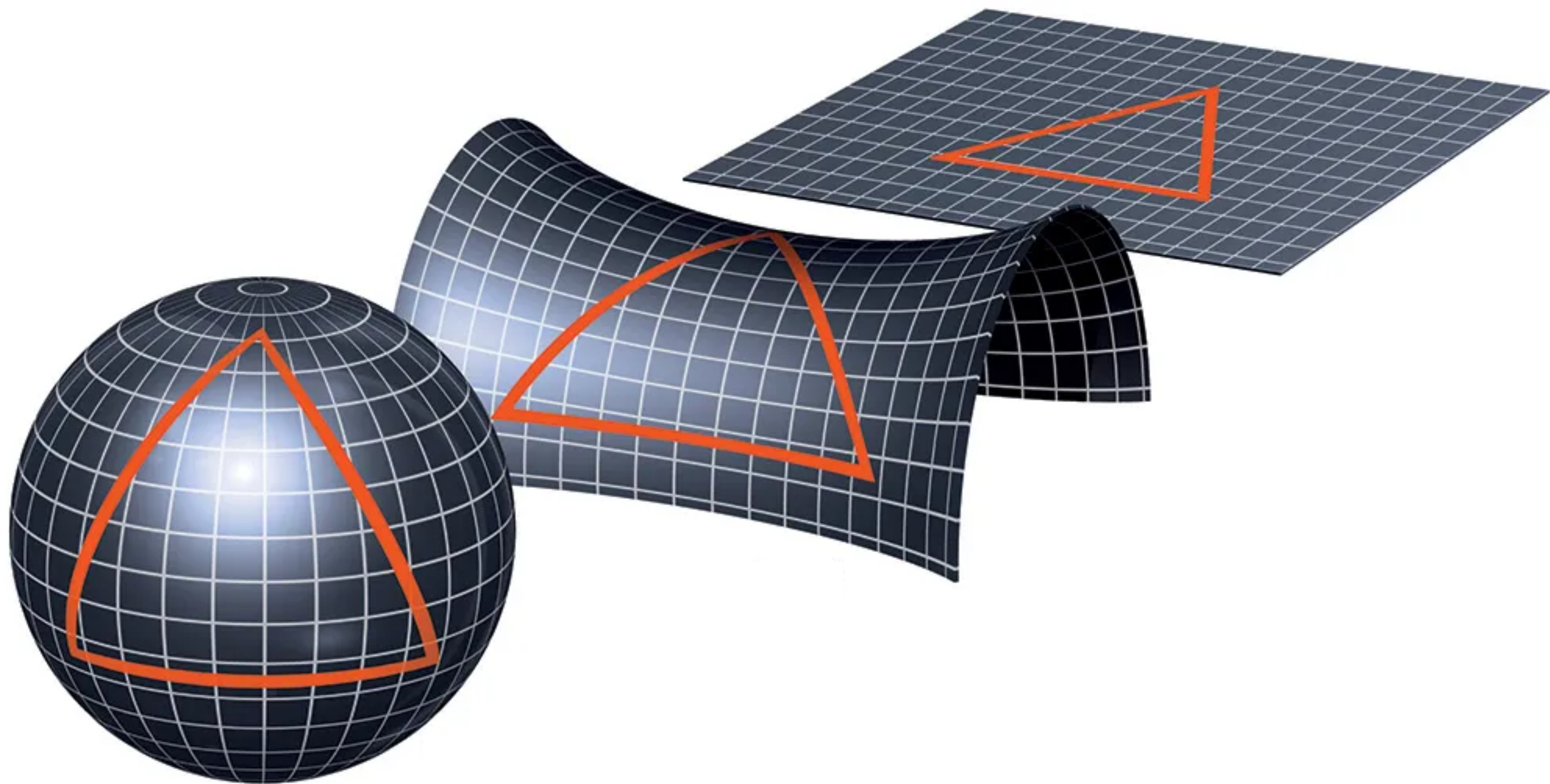

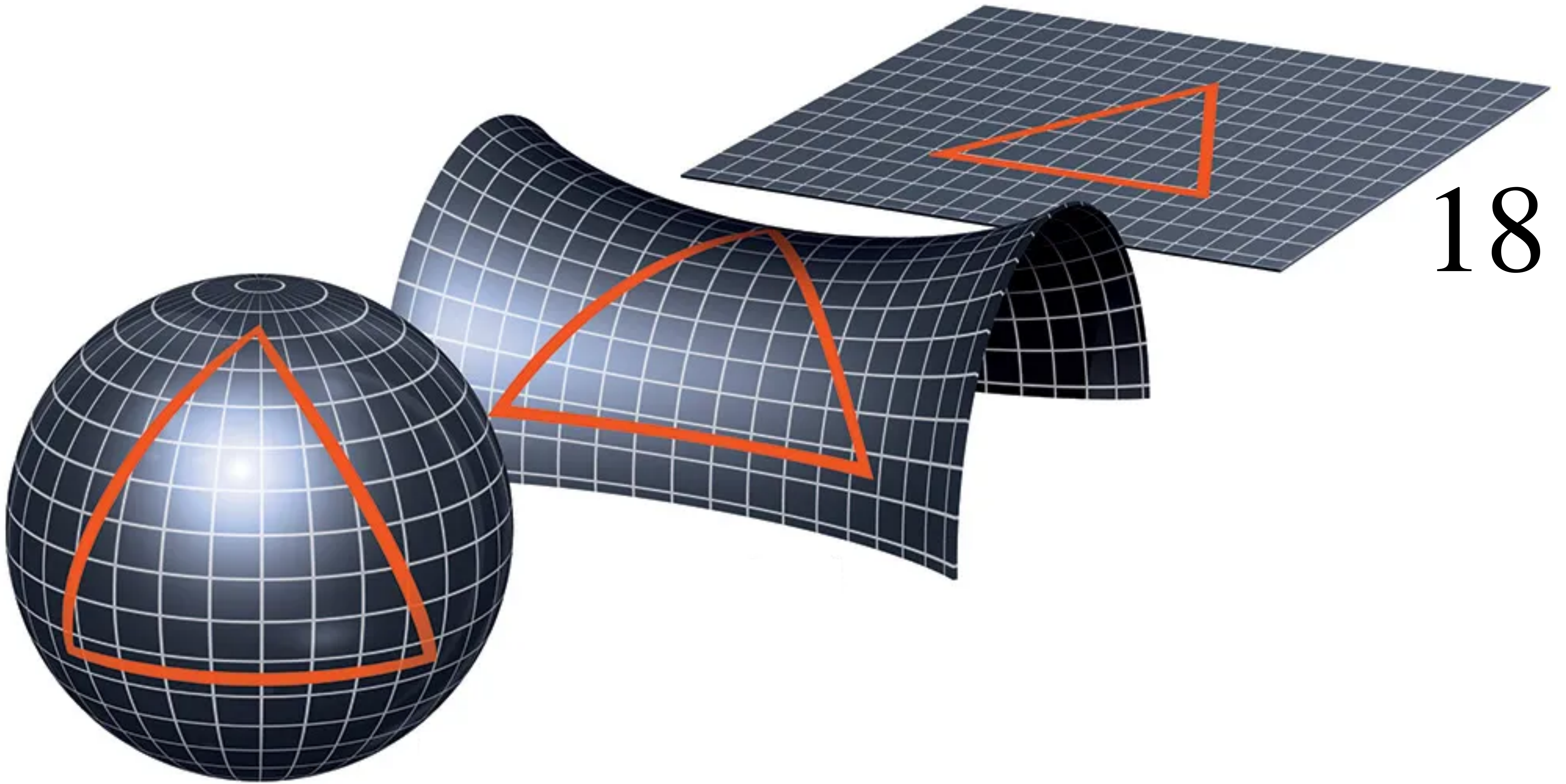

18

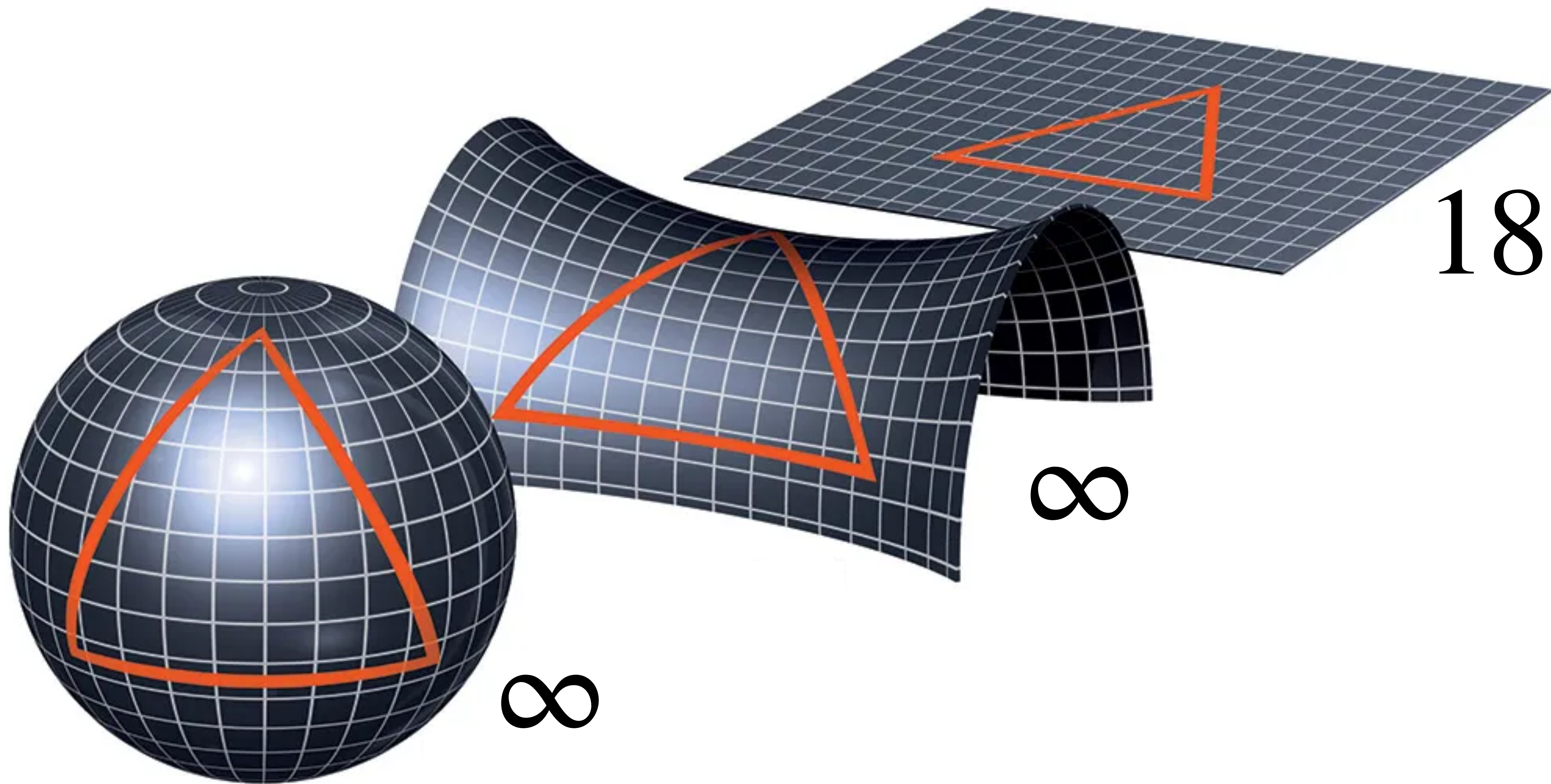

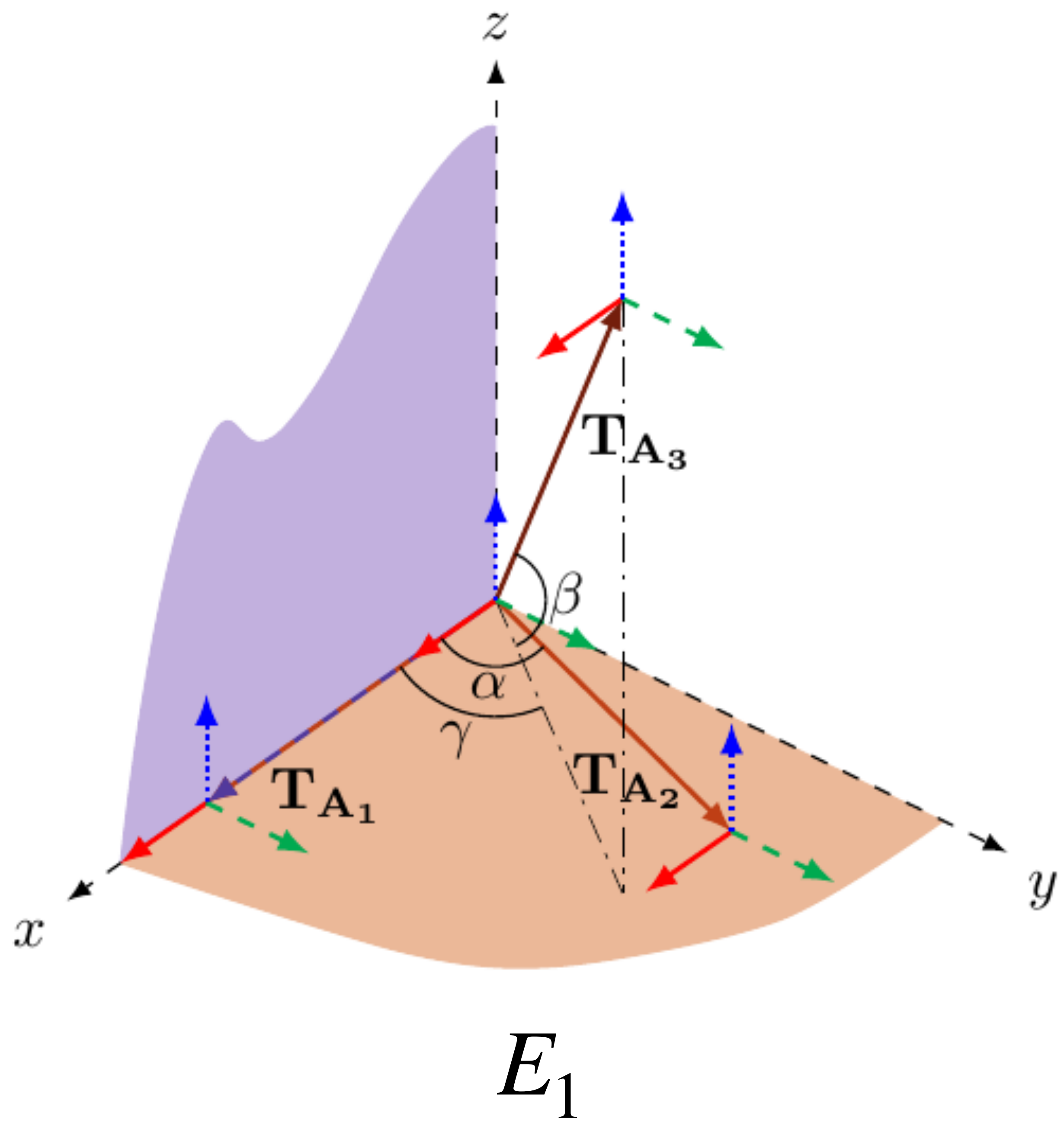

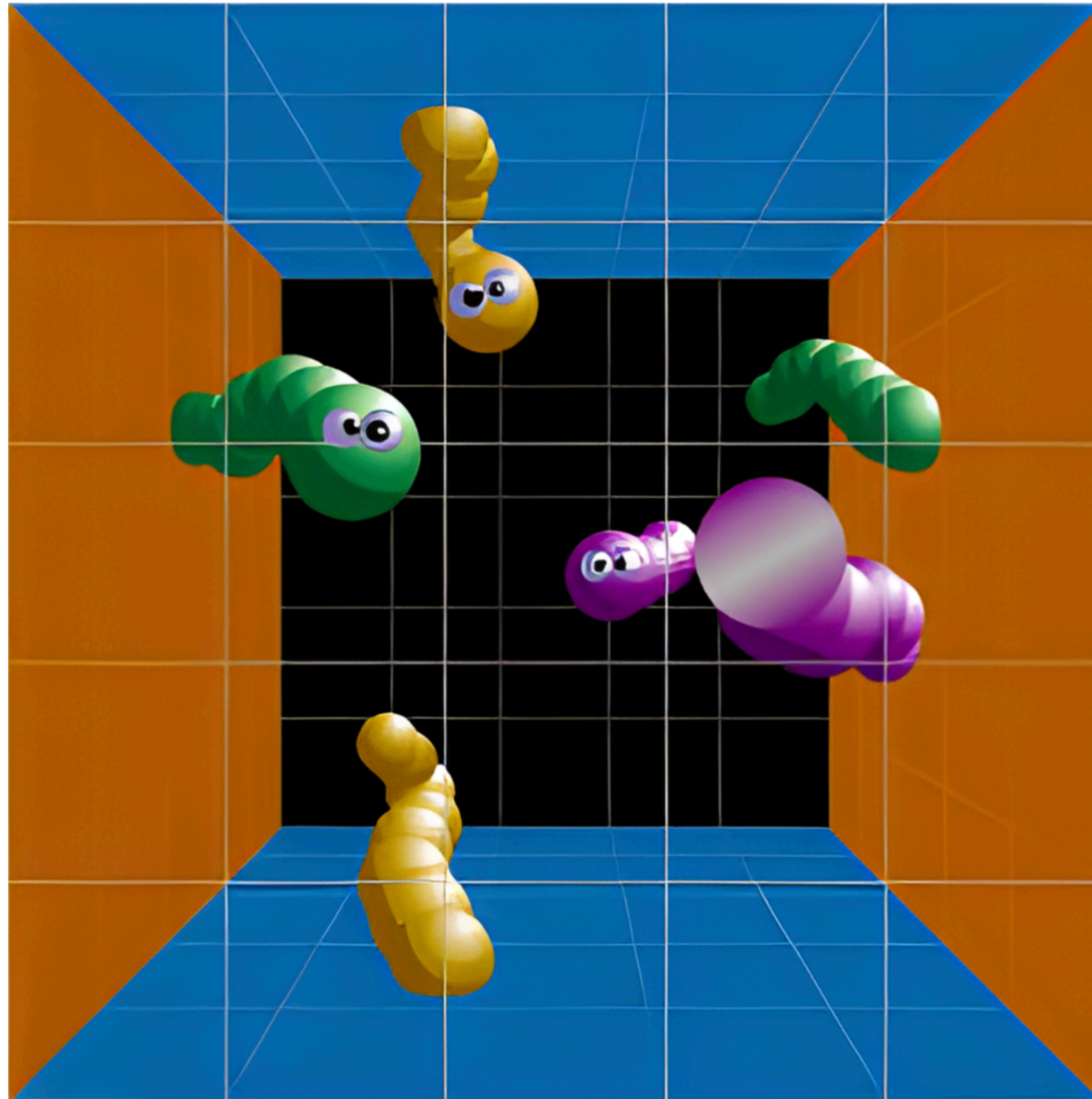

E_1

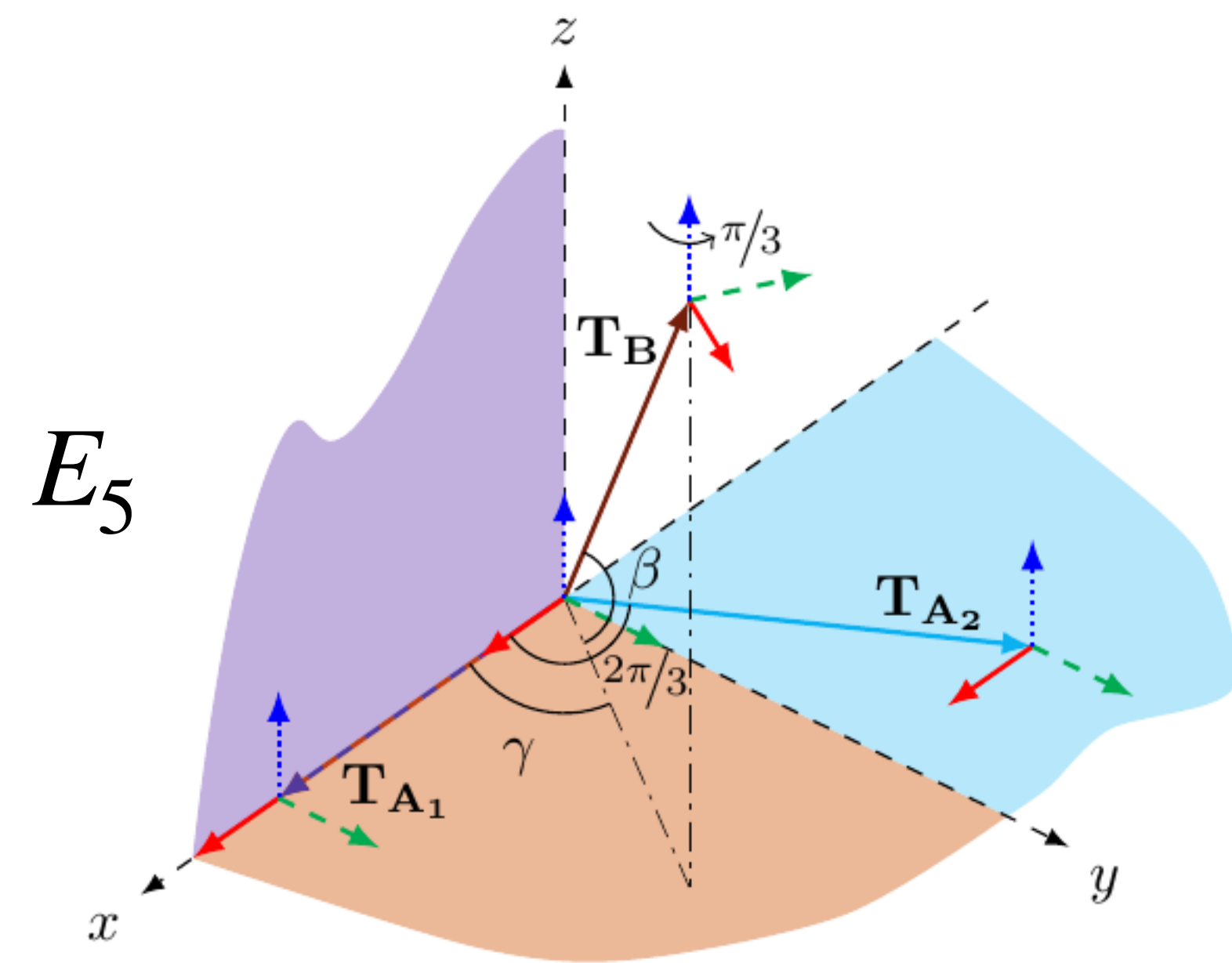
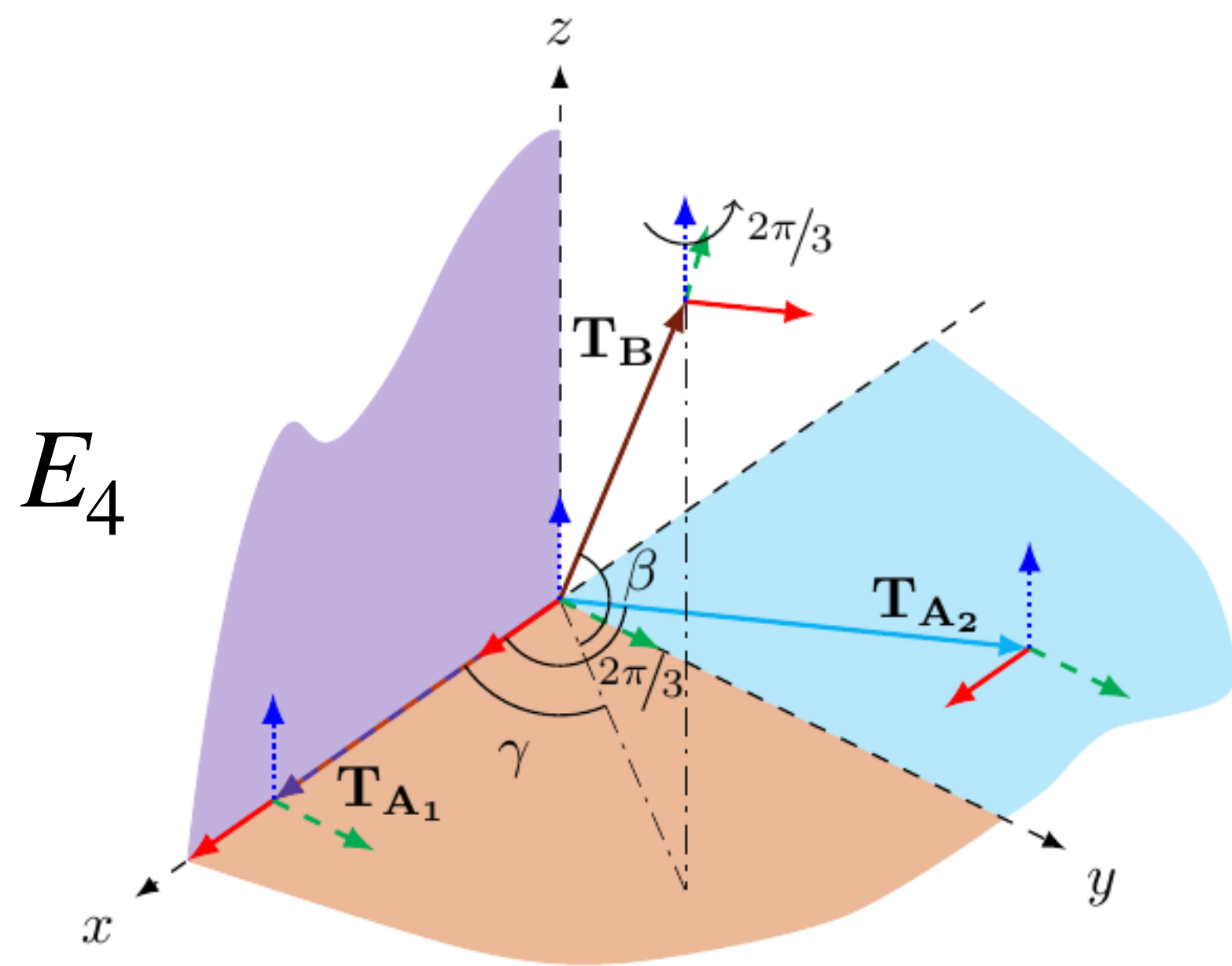
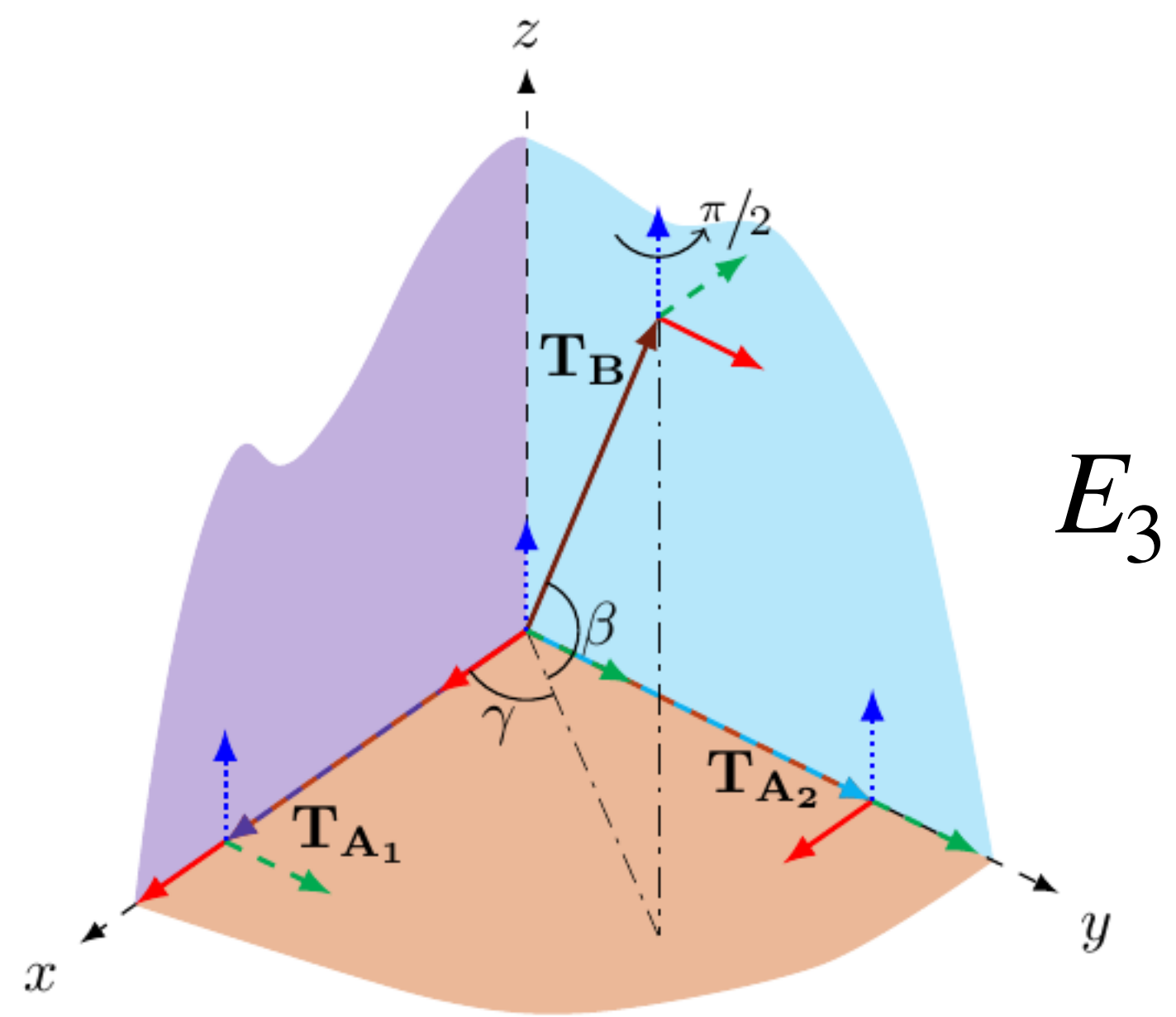
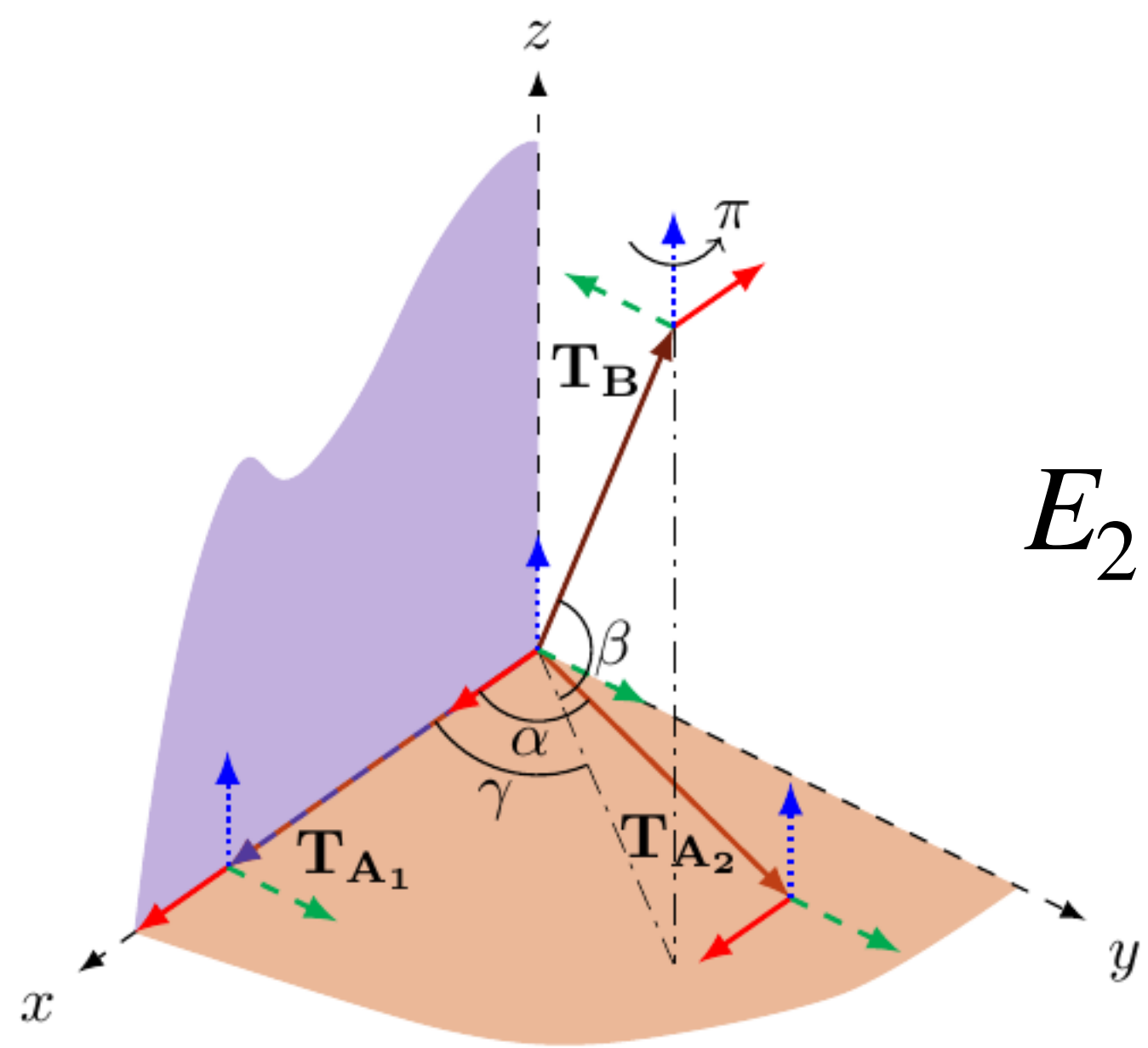

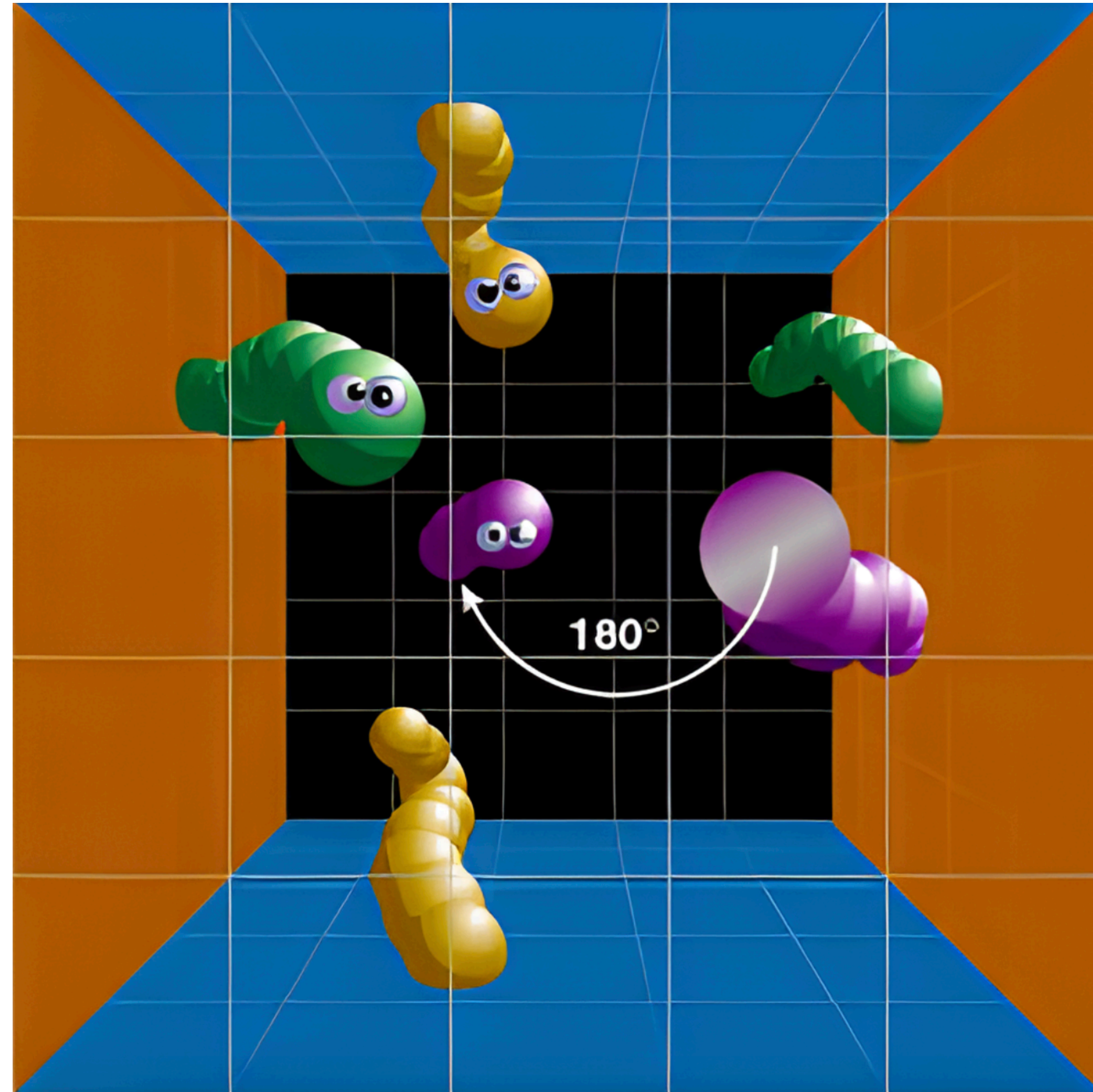

E_2

Klein topologies

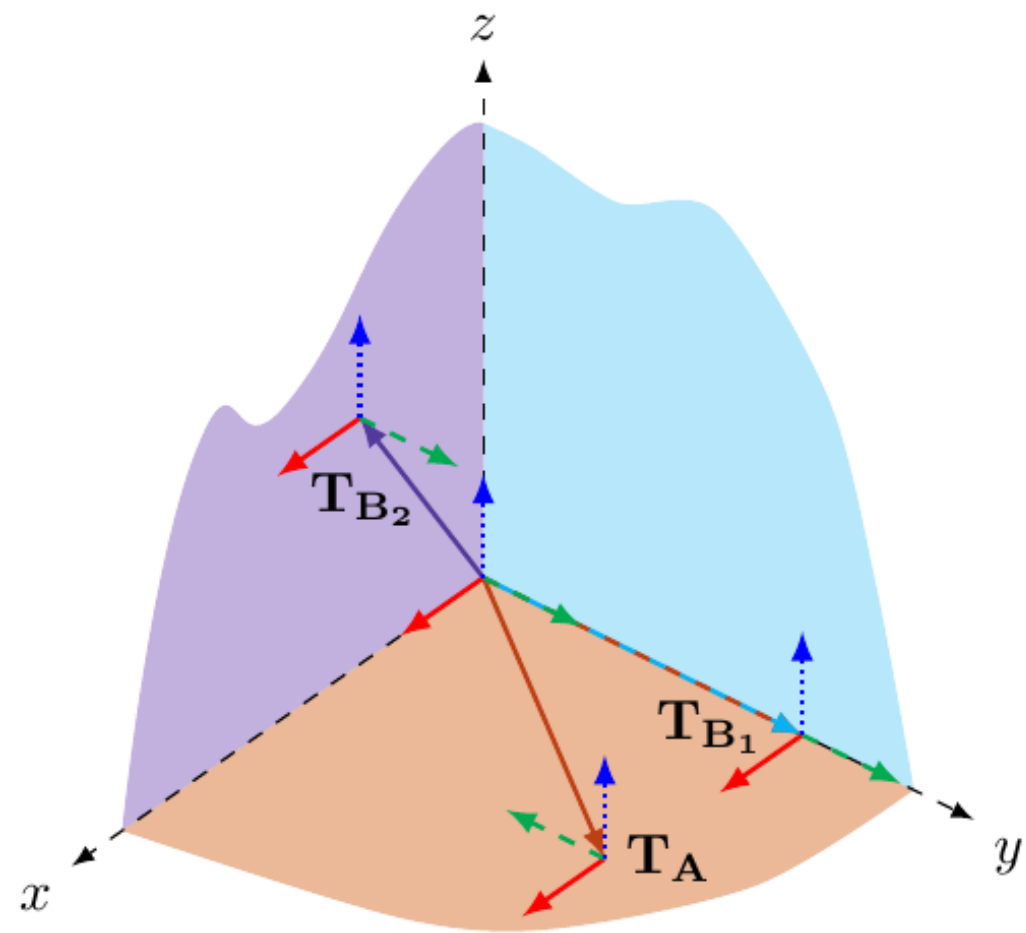

E_7

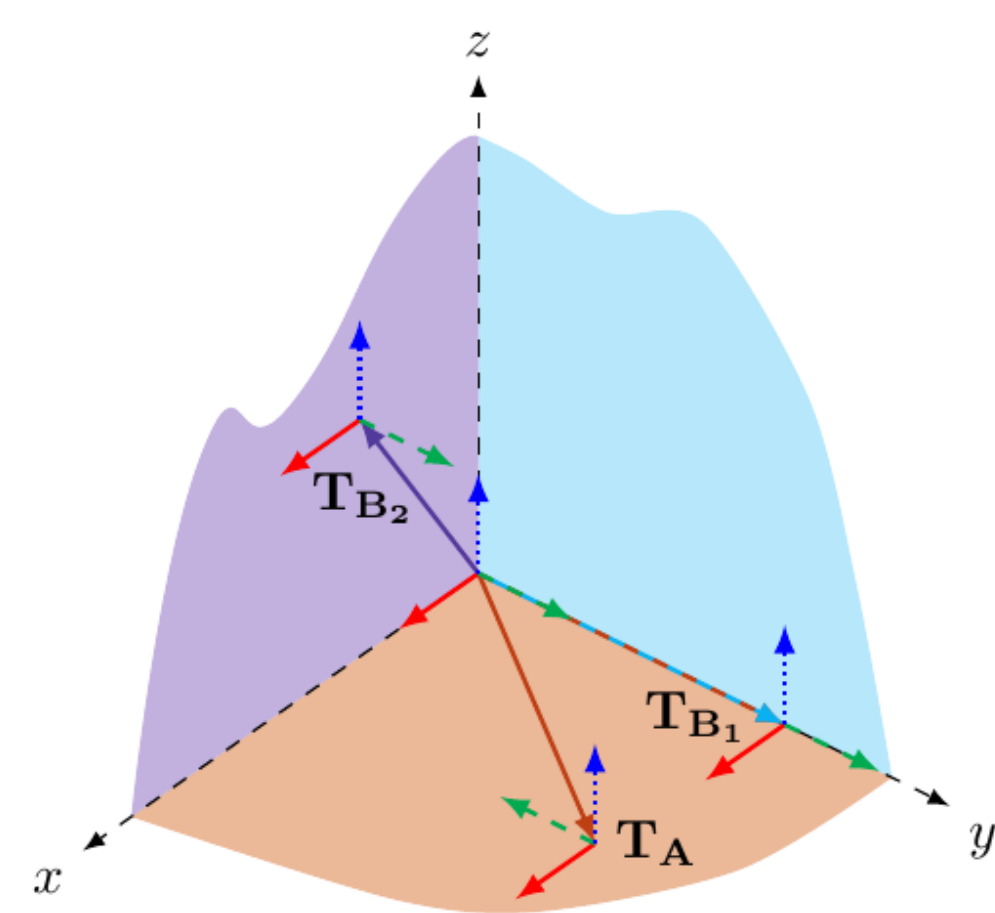

E_8

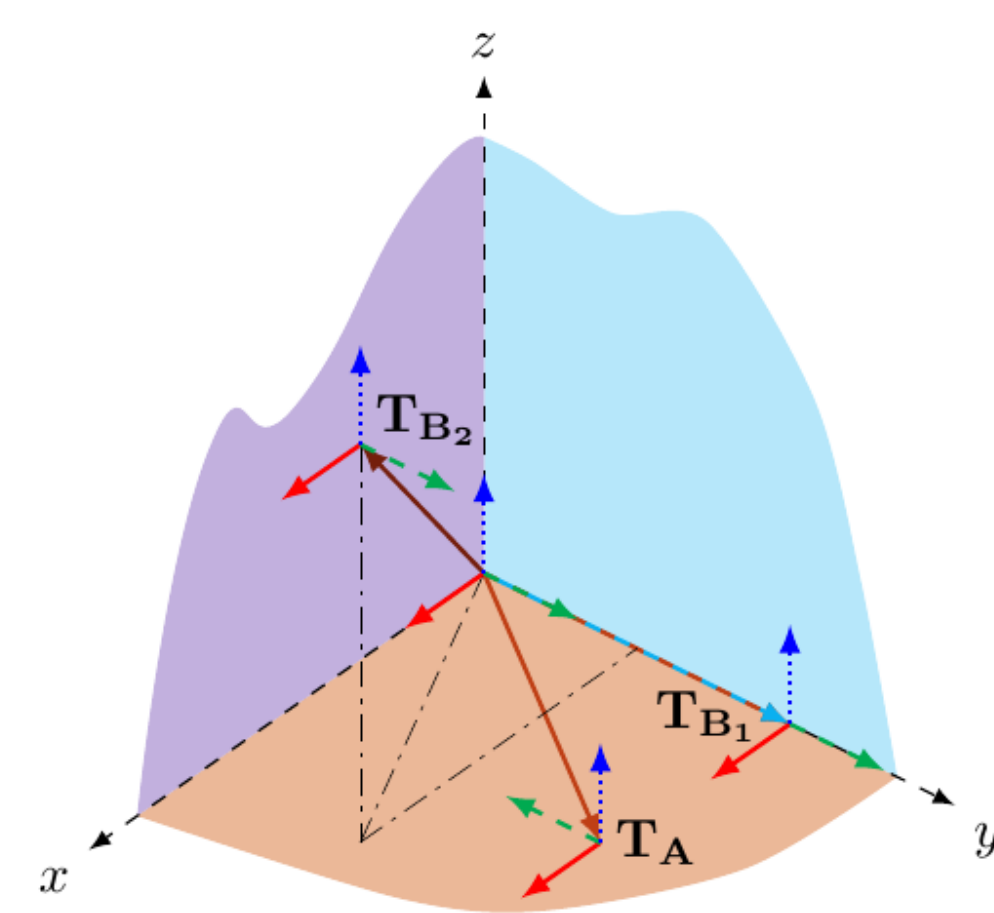

E_9

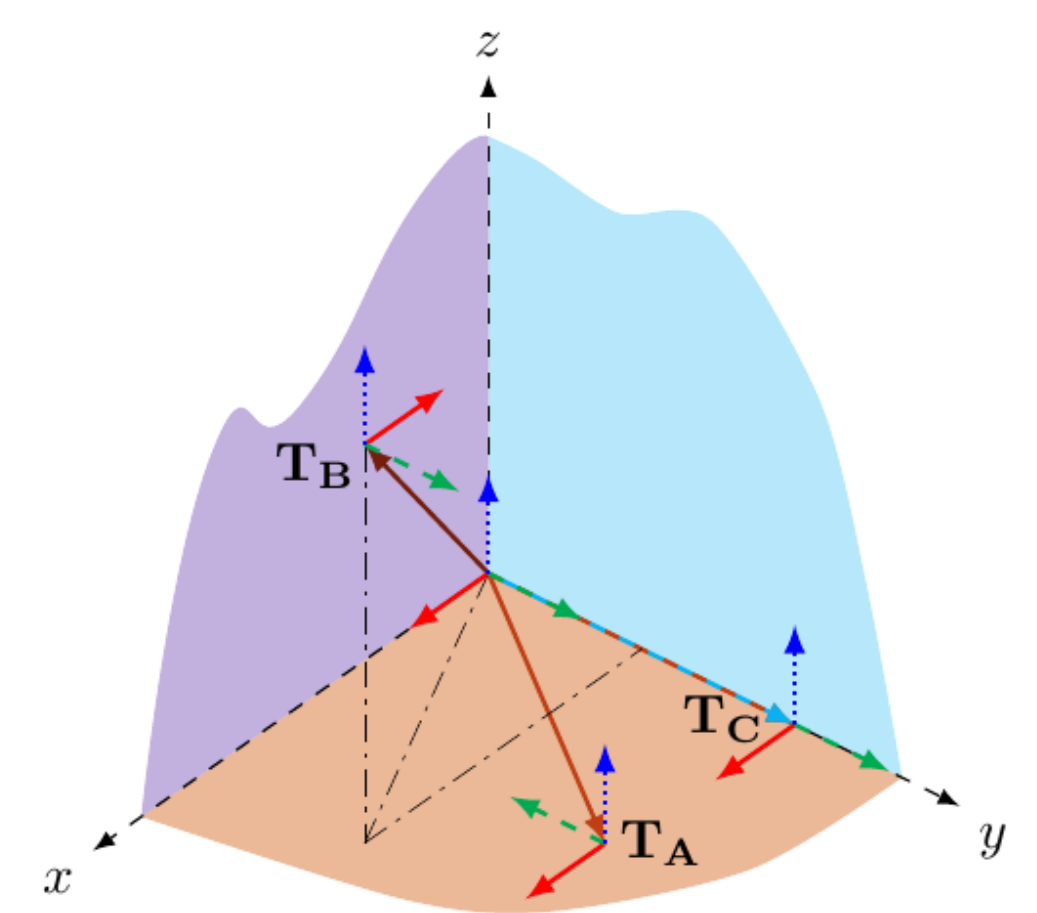

E_{10}

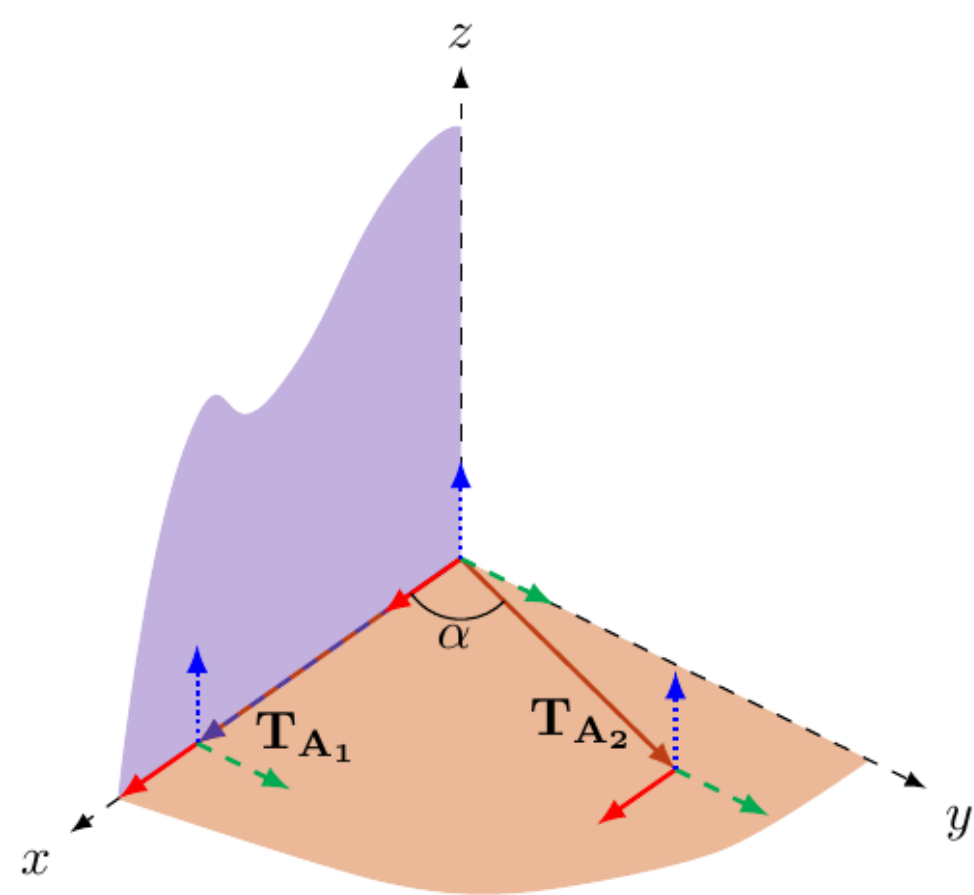

E_{11}

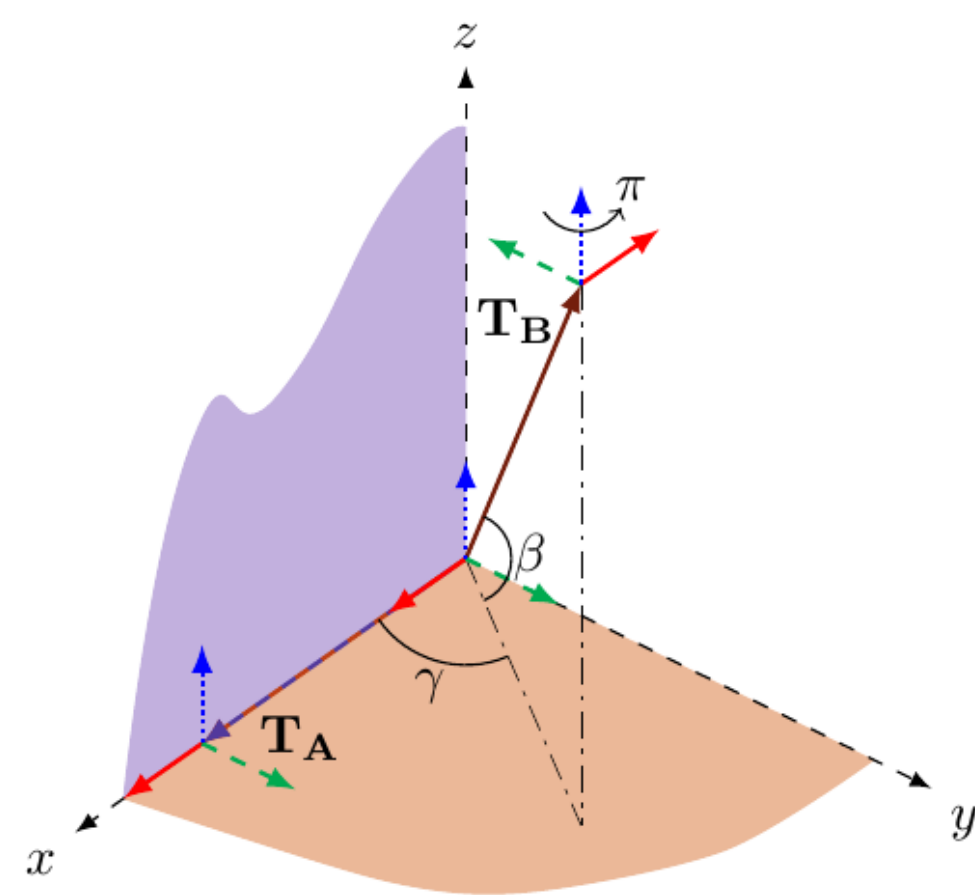

E_{12}

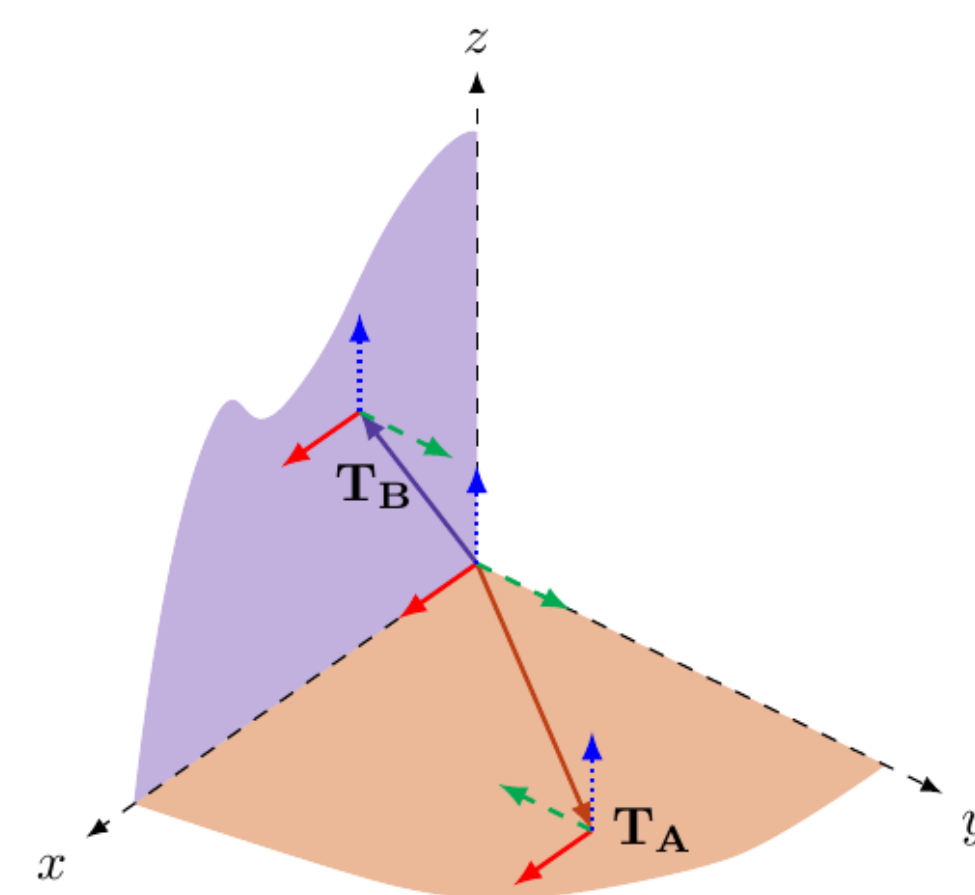

E_{13}

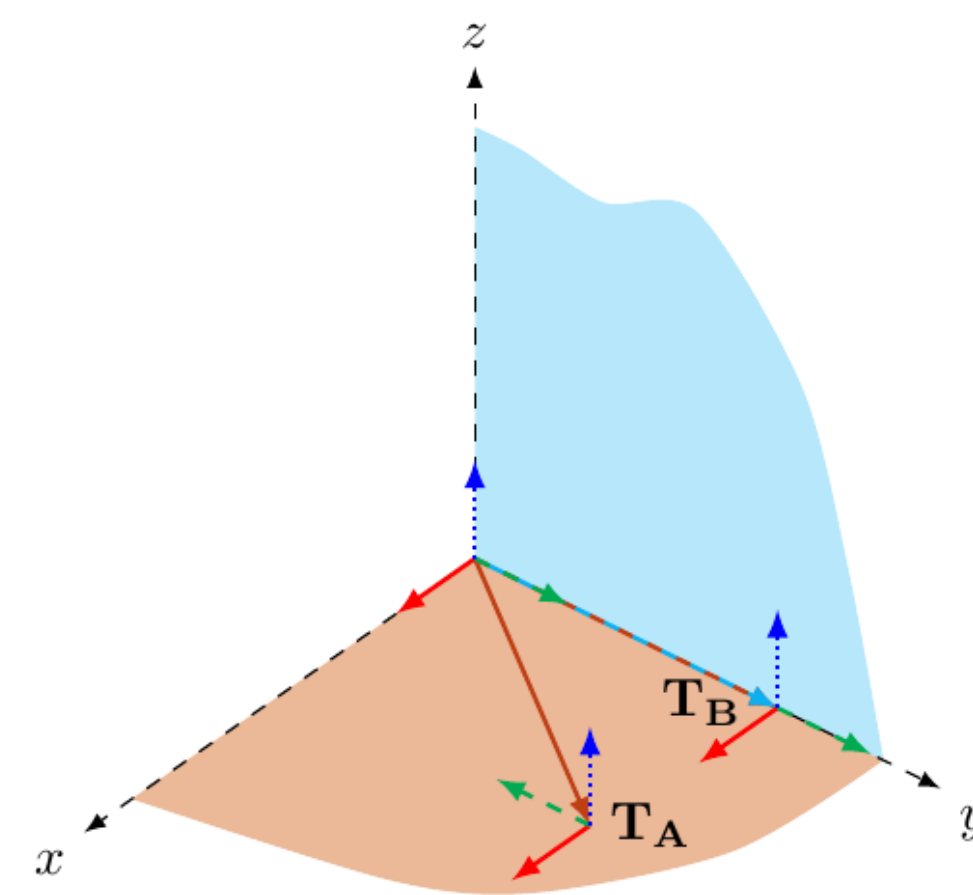

E_{14}

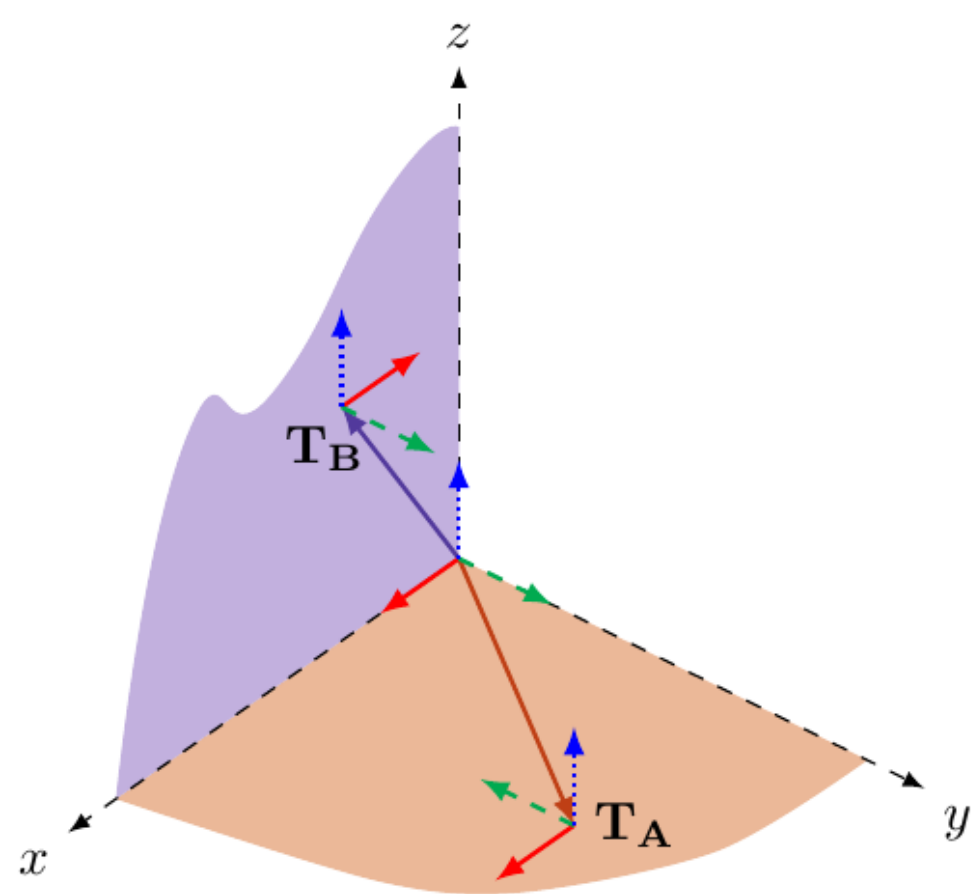

E_{15}

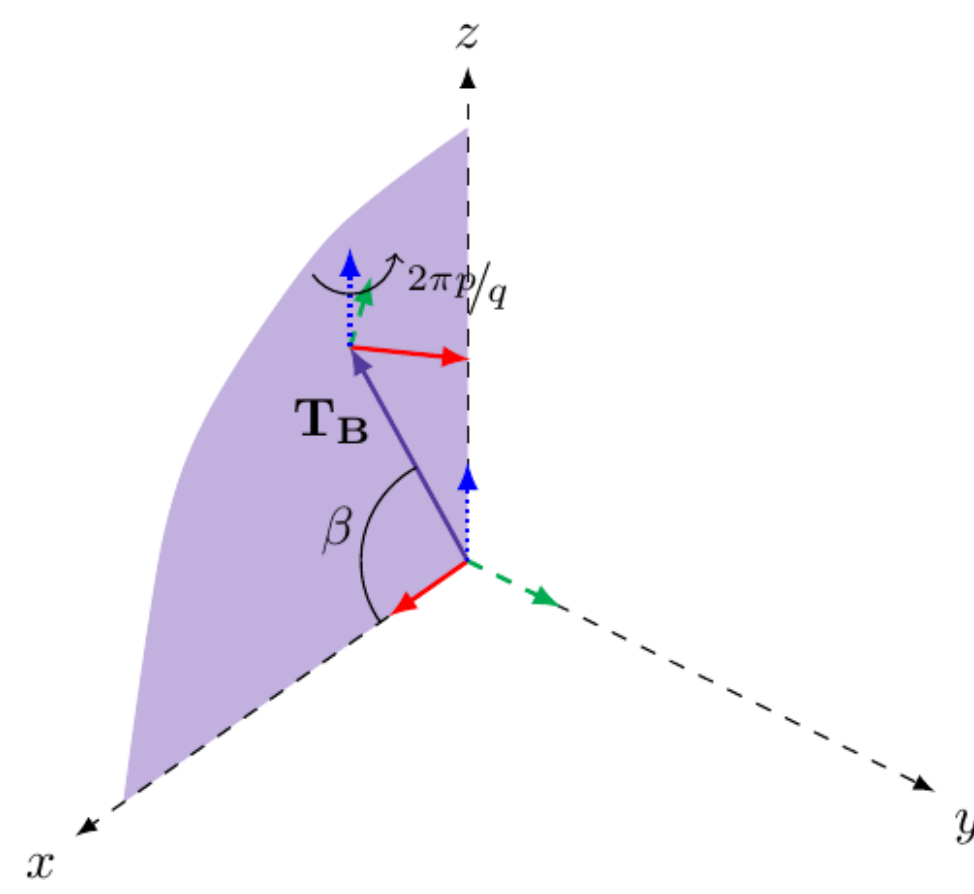

E_{16i}

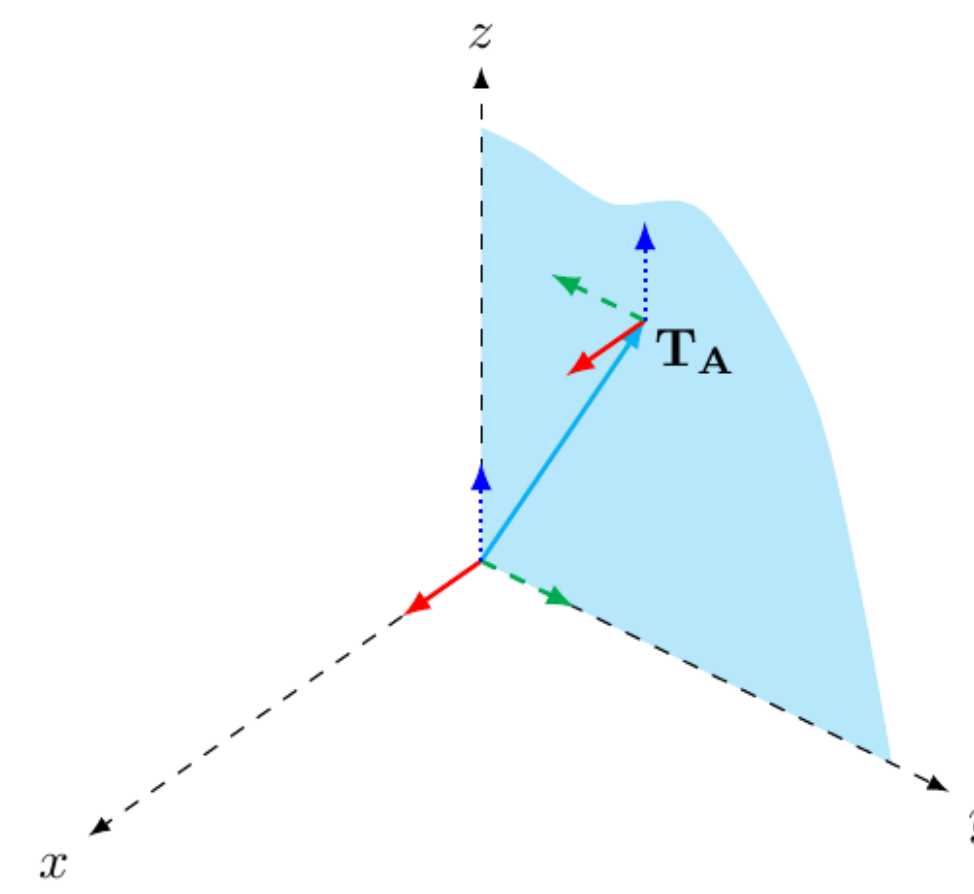

E_{17}

Hantzsche-Wendt topology

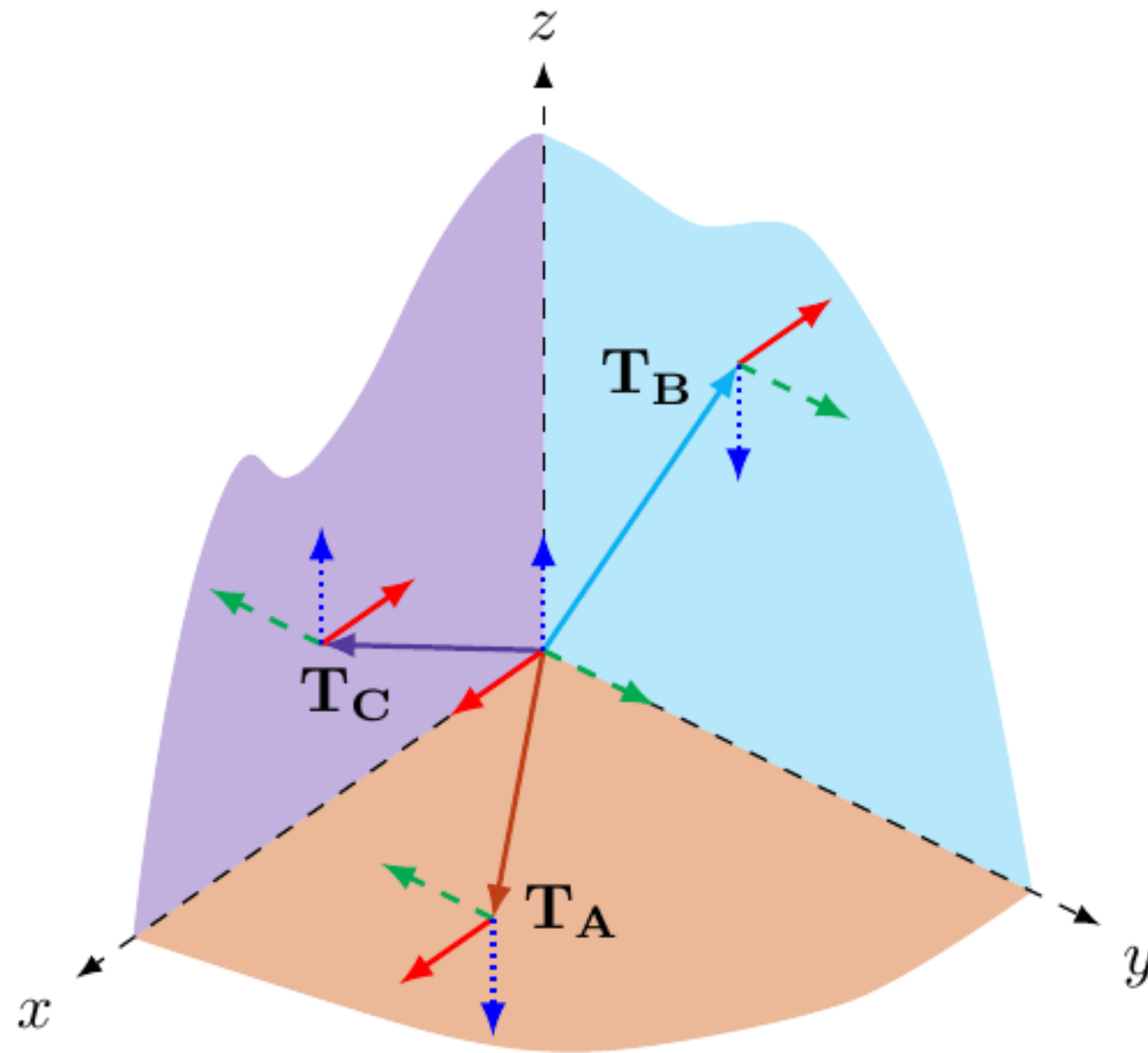

E_6

Hantzsche-Wendt topology

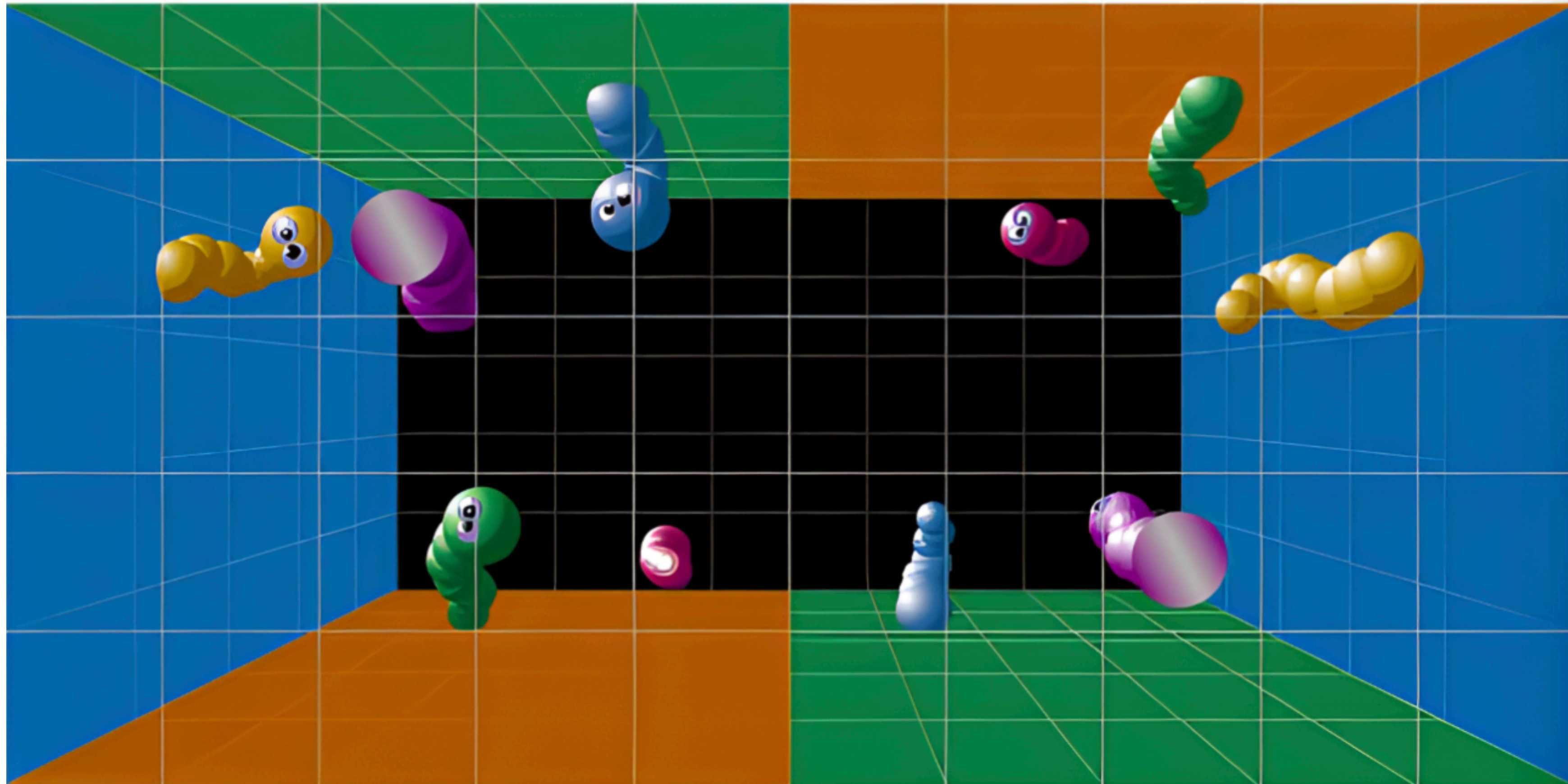

E_6

Classification of topologies

Classification of topologies



ORIENTABLE

Classification of topologies



ORIENTABLE



FINITE

Classification of topologies



ORIENTABLE



FINITE



HOMOGENEOUS

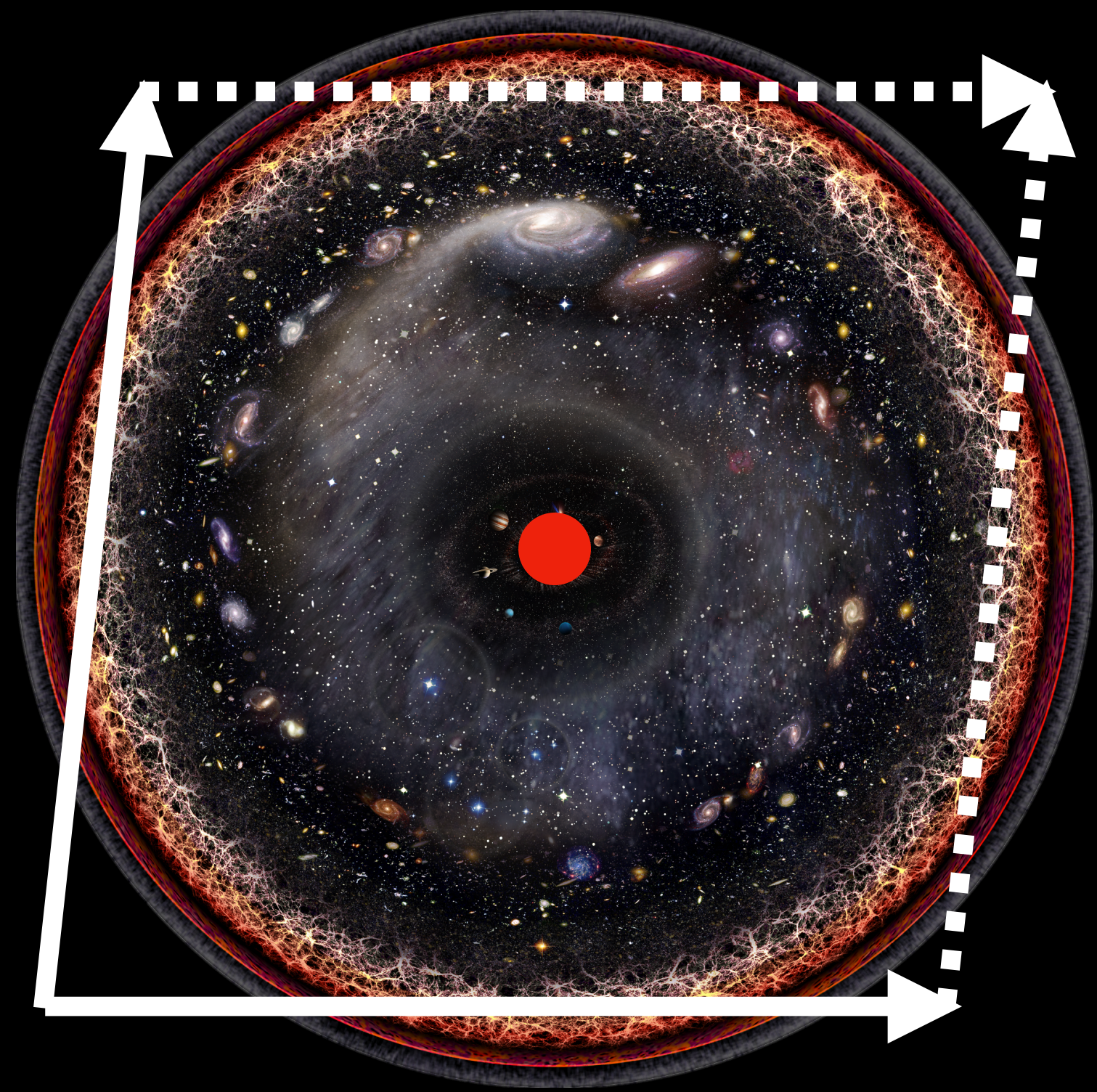



200,000 units are ready, with a million more well on the way

Clone search

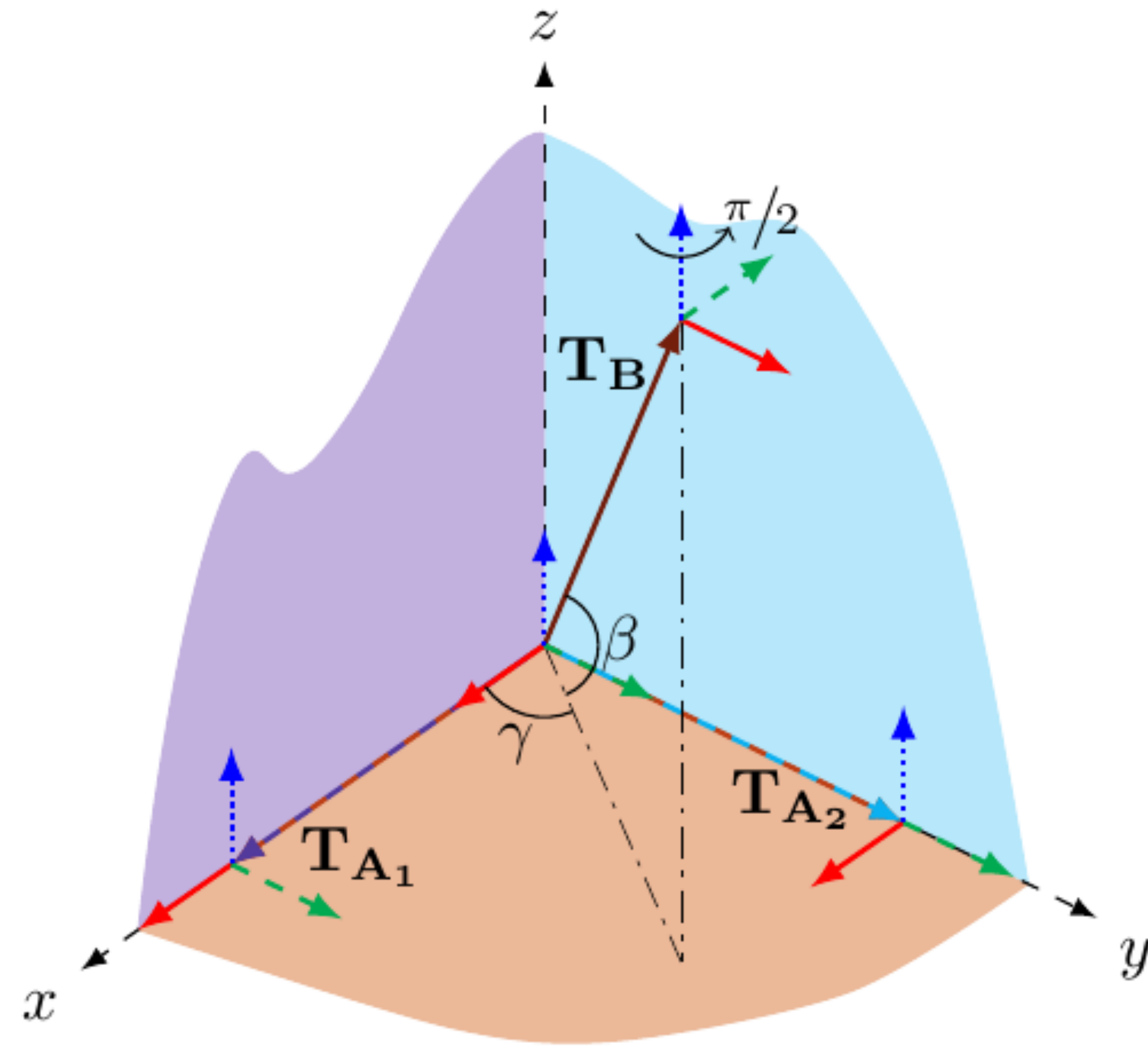

E_3

Clone search

Step 1:
Non-trivial
generators

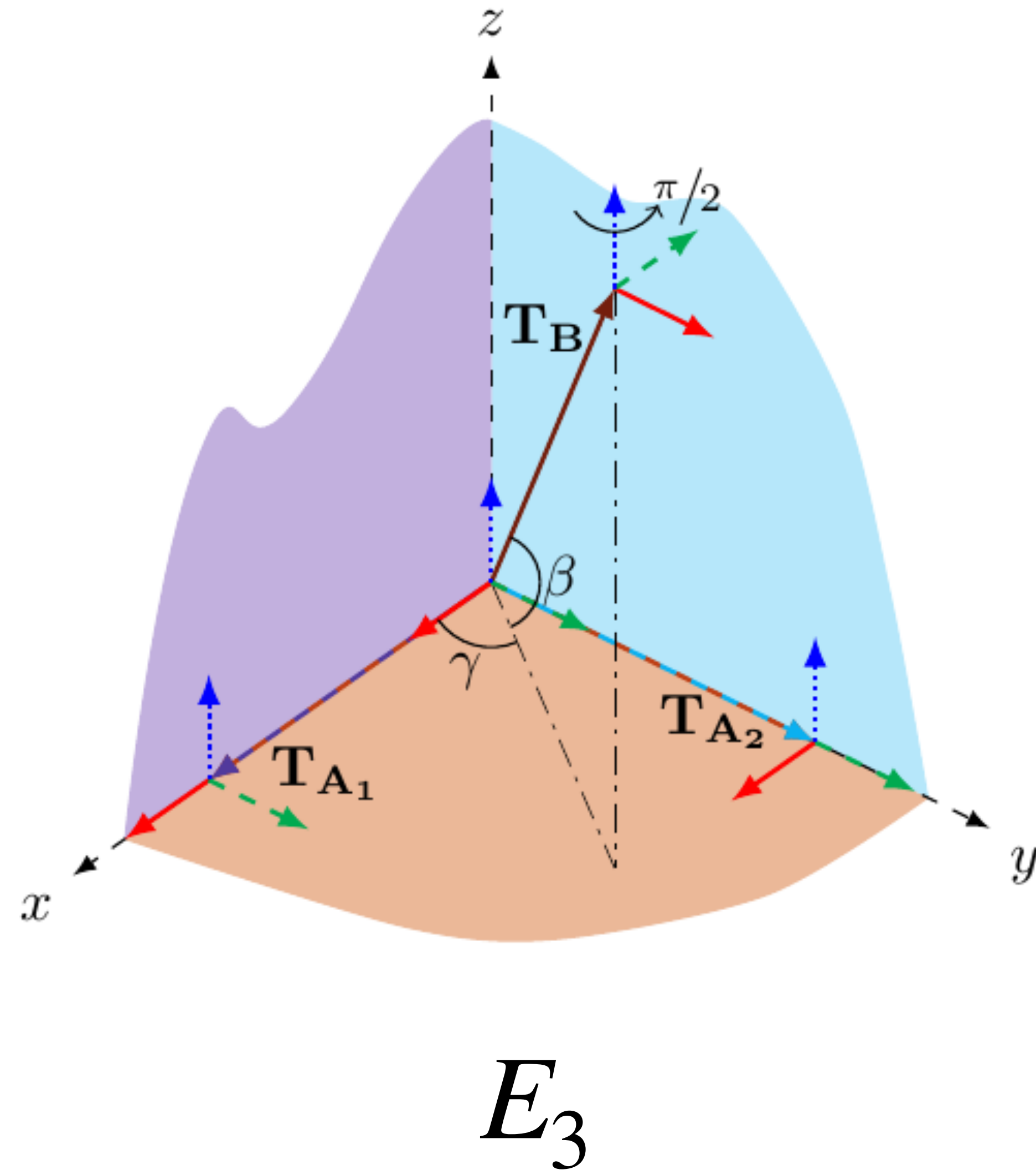

Clone search

Step 1:
Non-trivial
generators

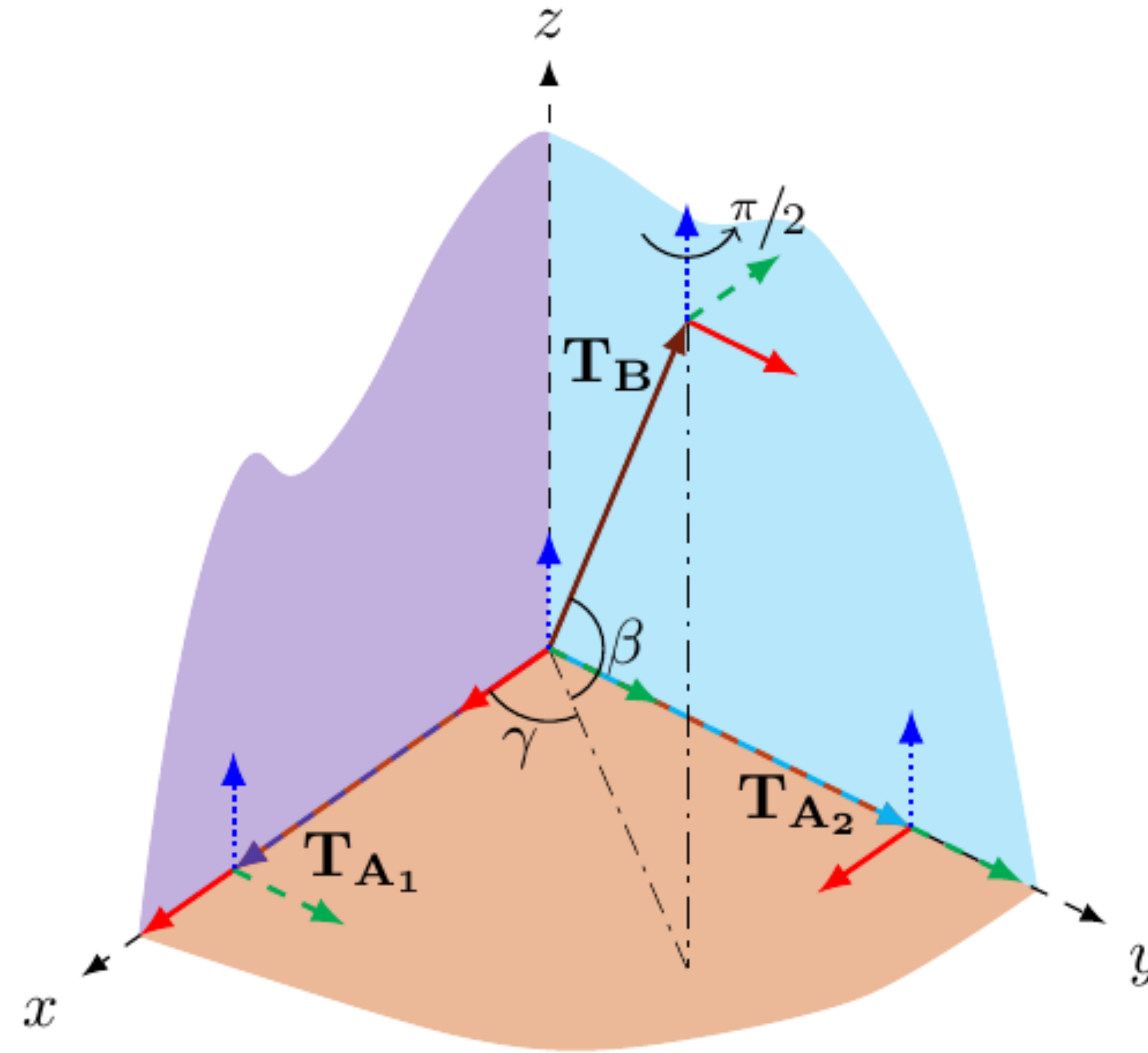

Step 2:
Pure
translations

E_3

Clone search

Step 1:
Non-trivial
generators

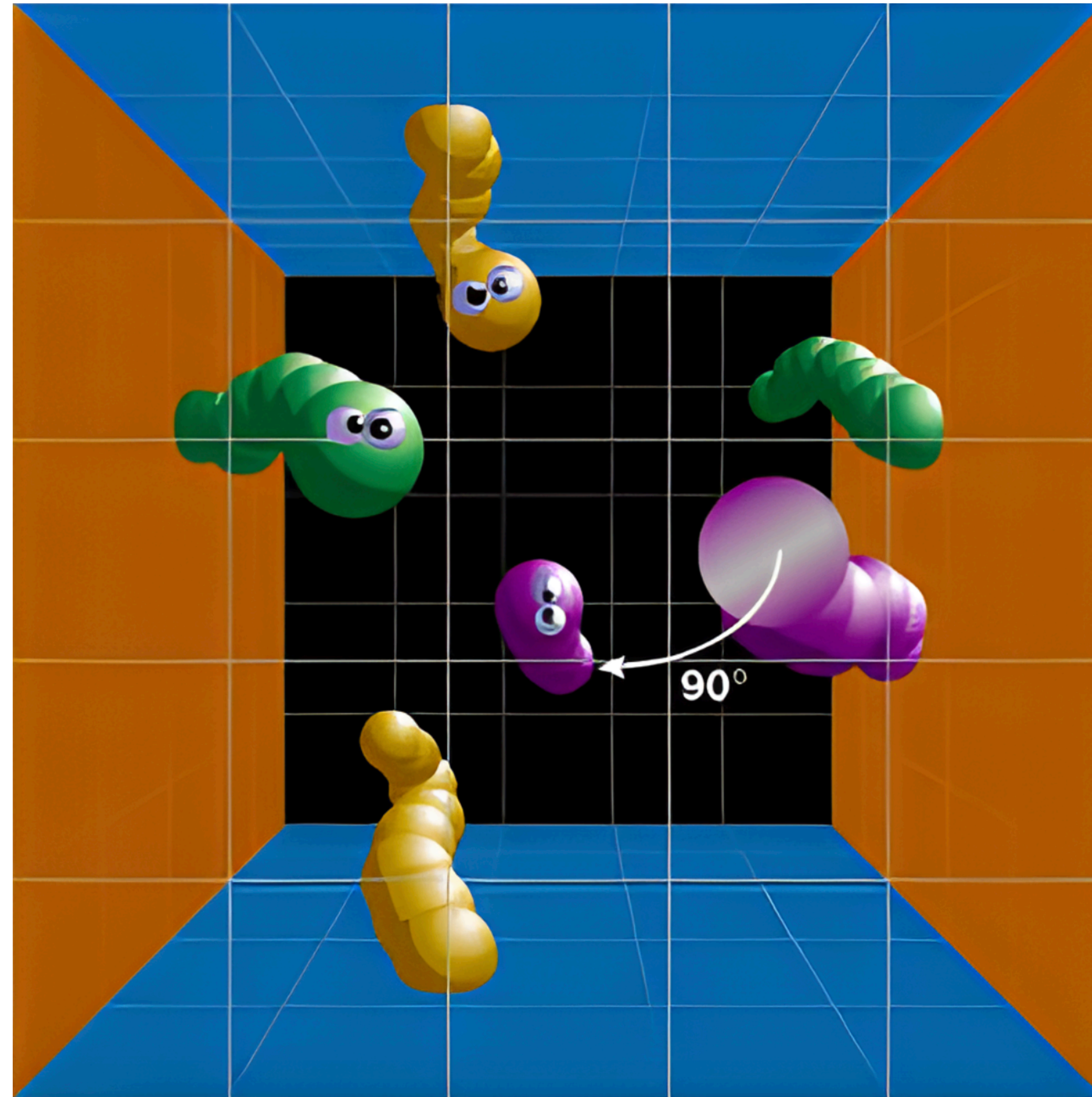

Step 2:
Pure
translations

E_3

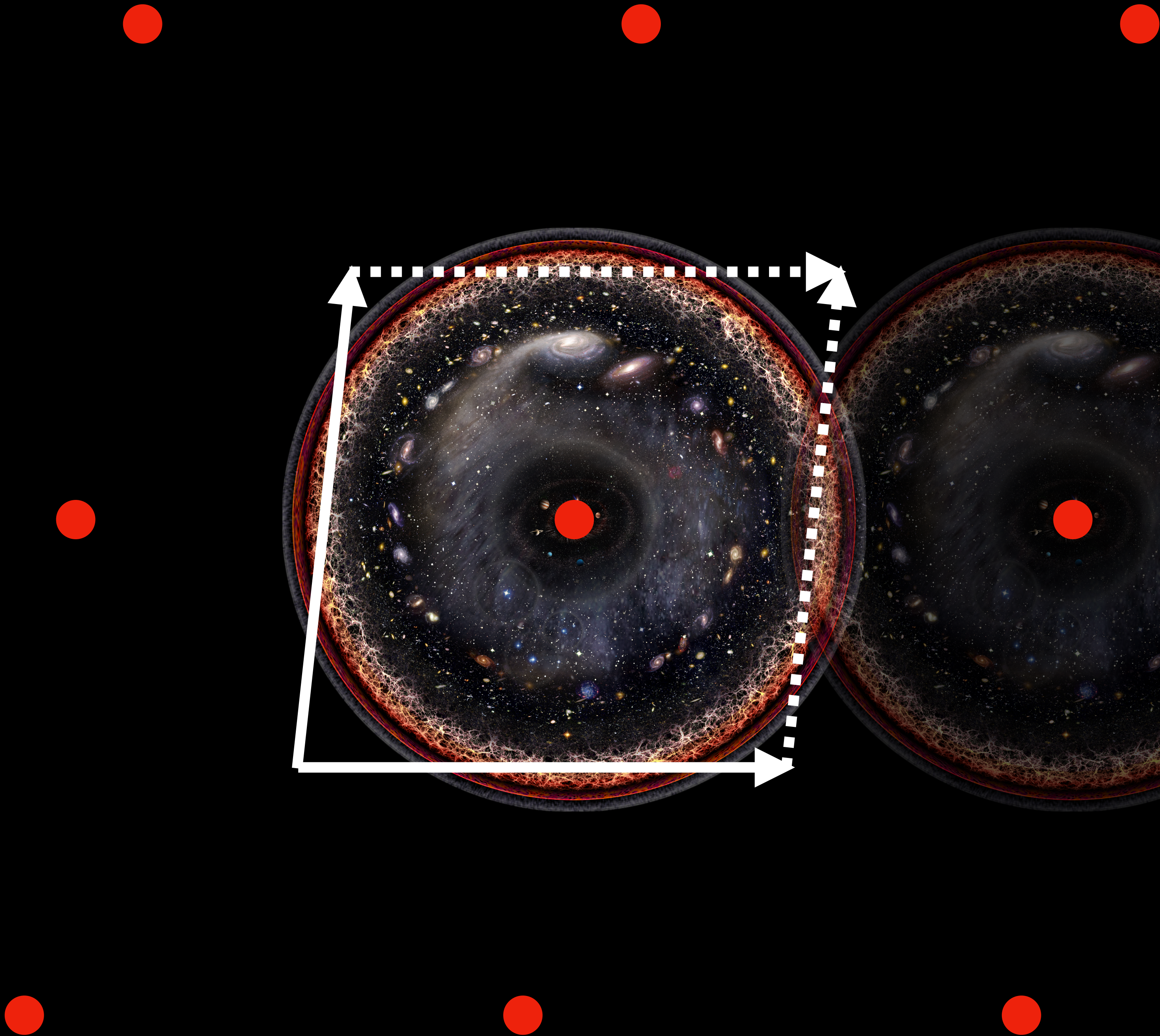





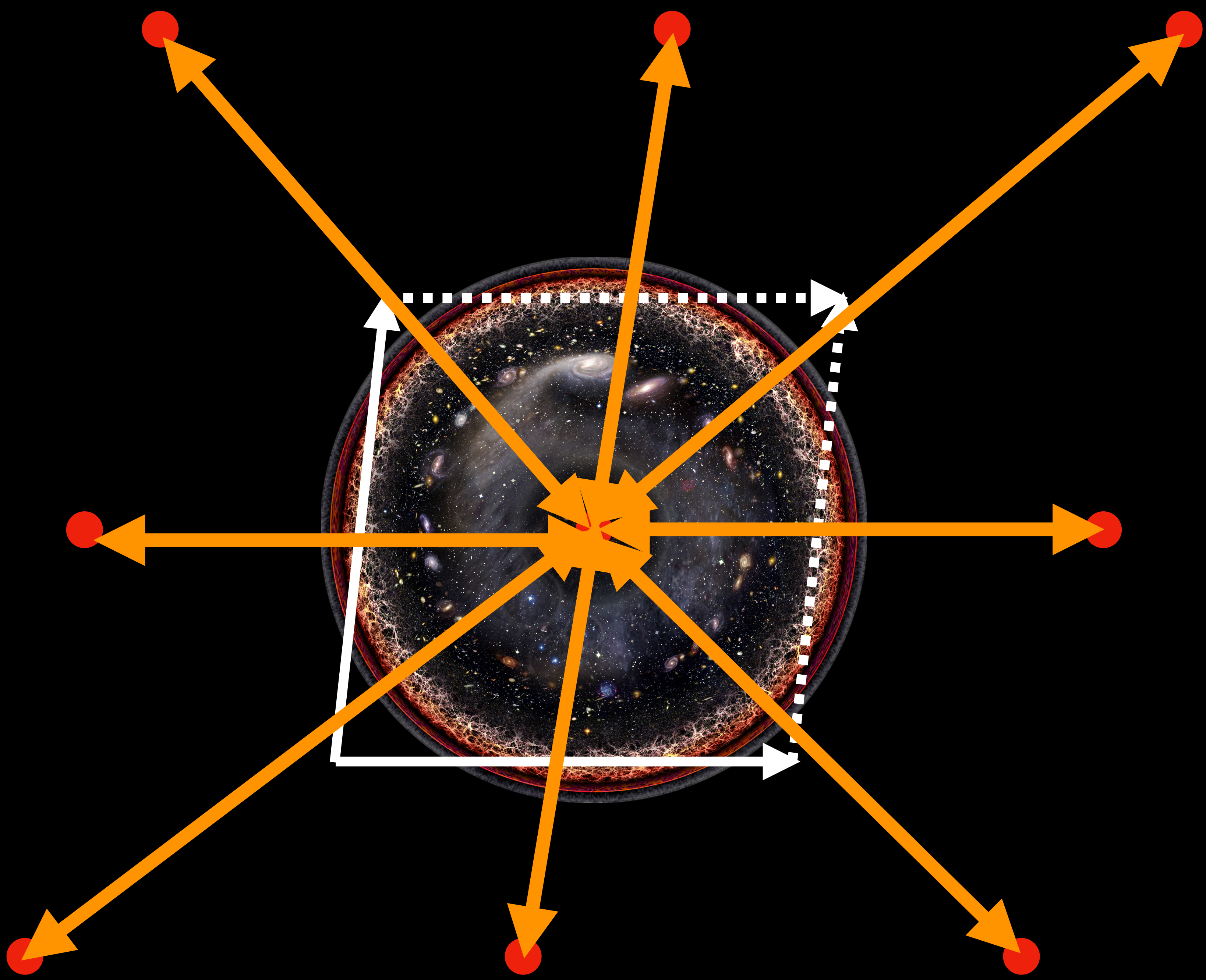



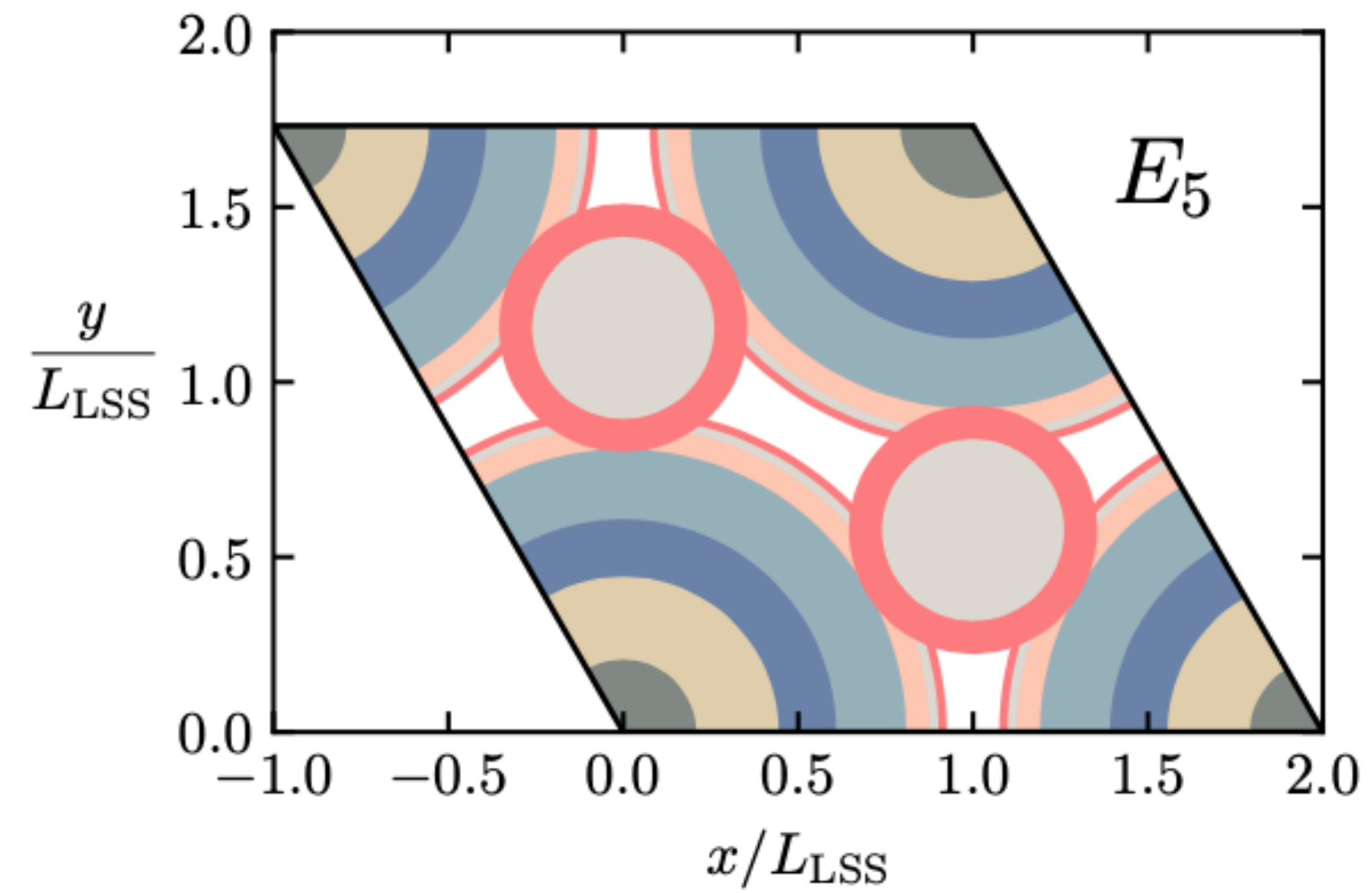
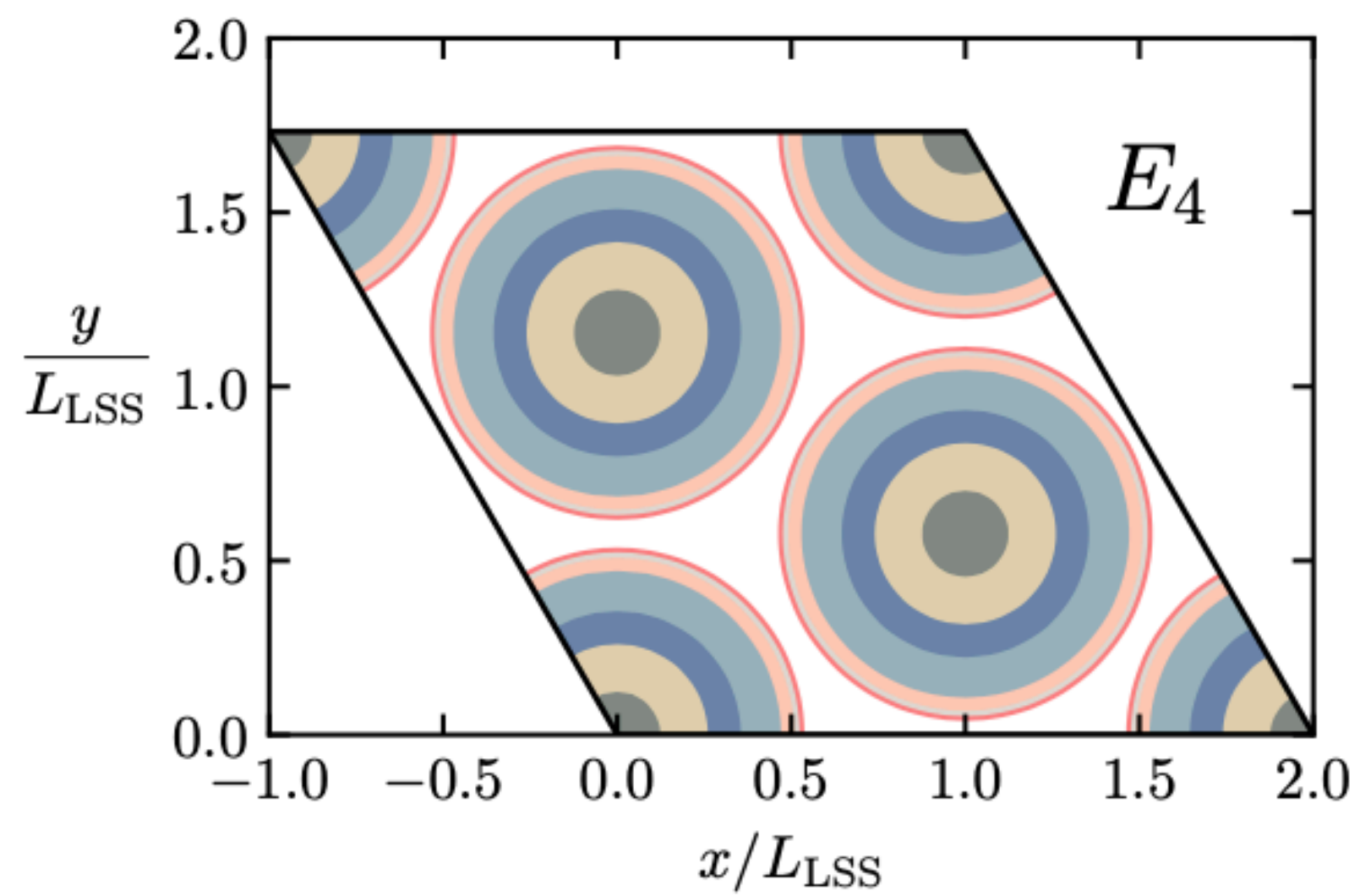
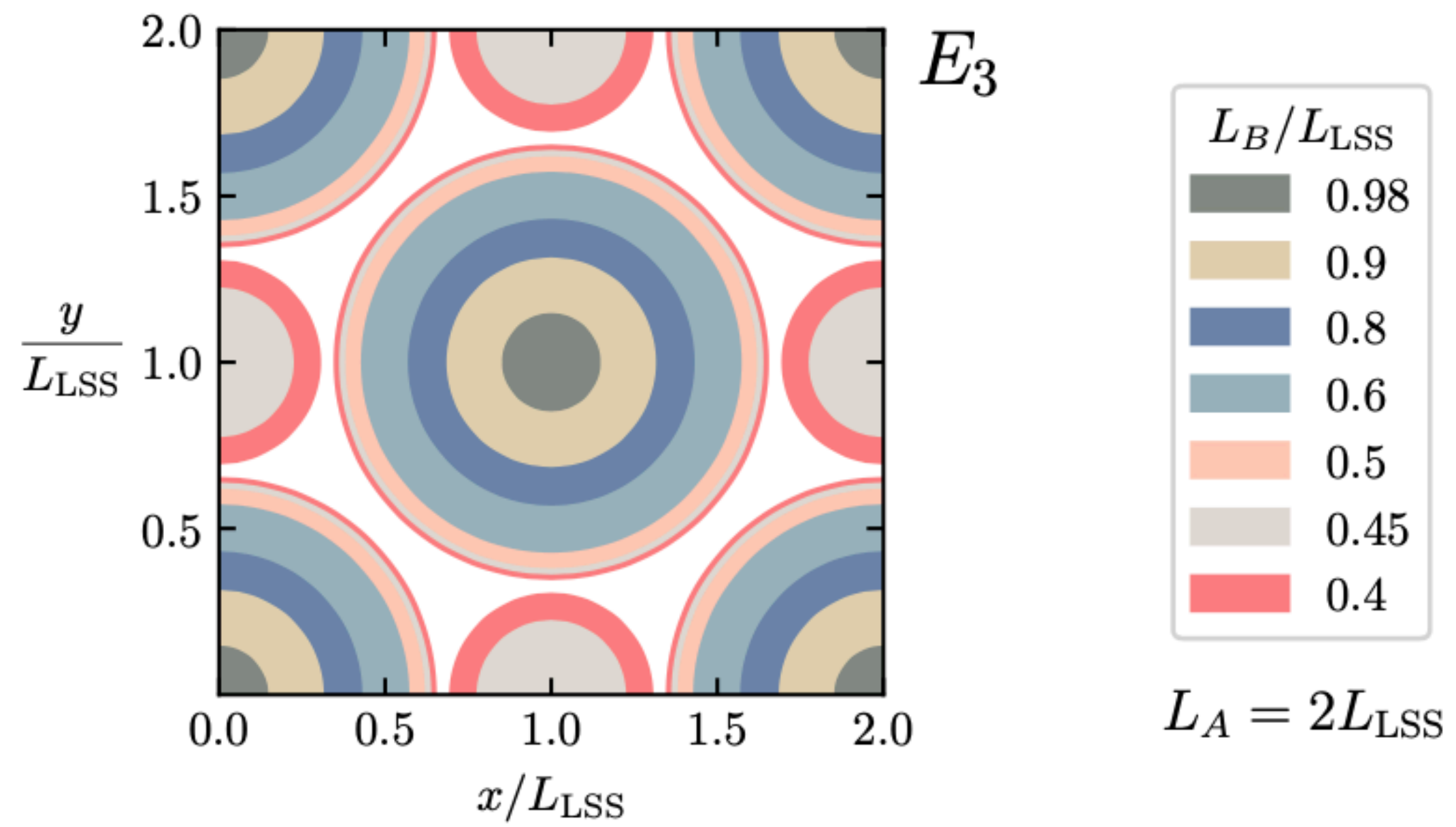

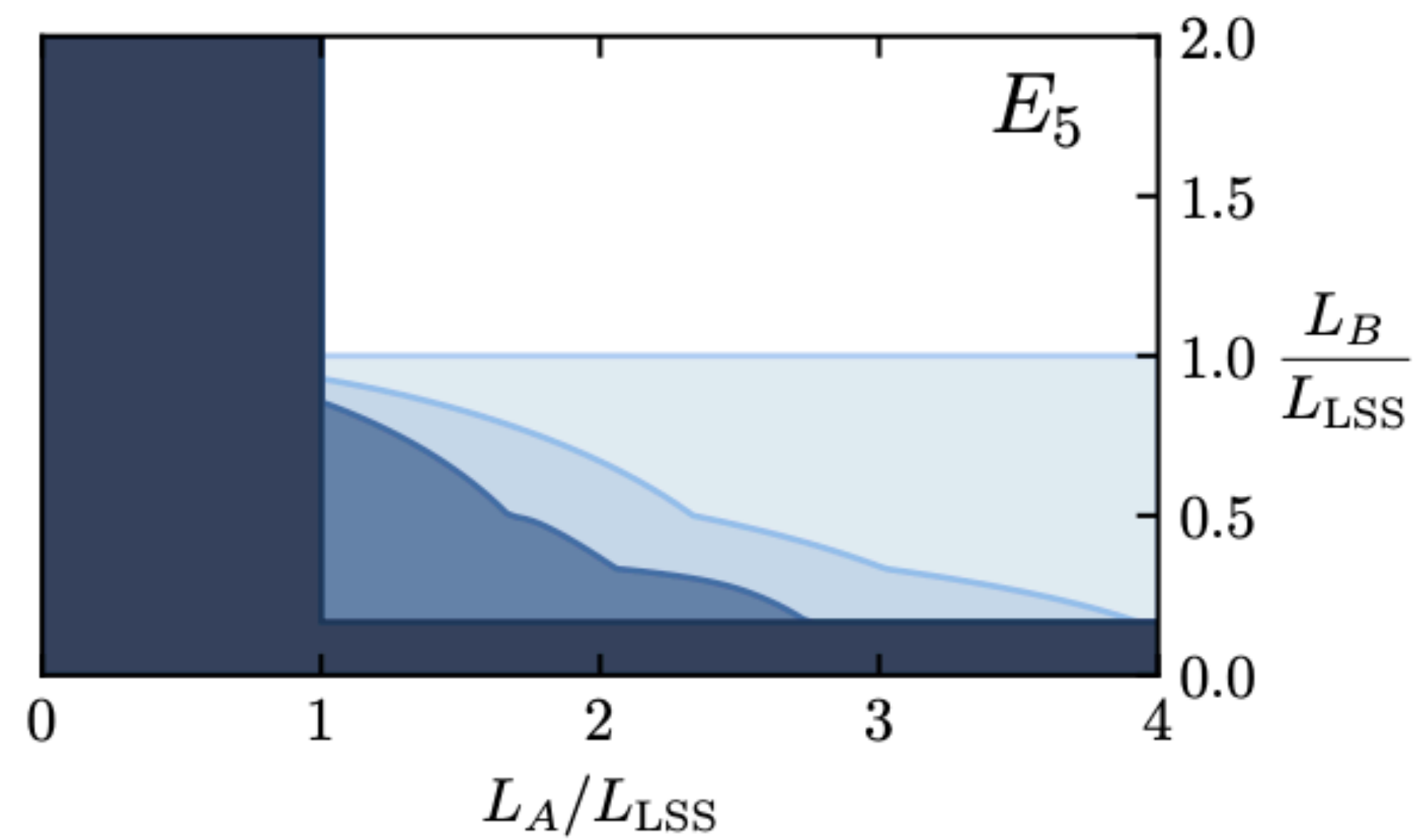
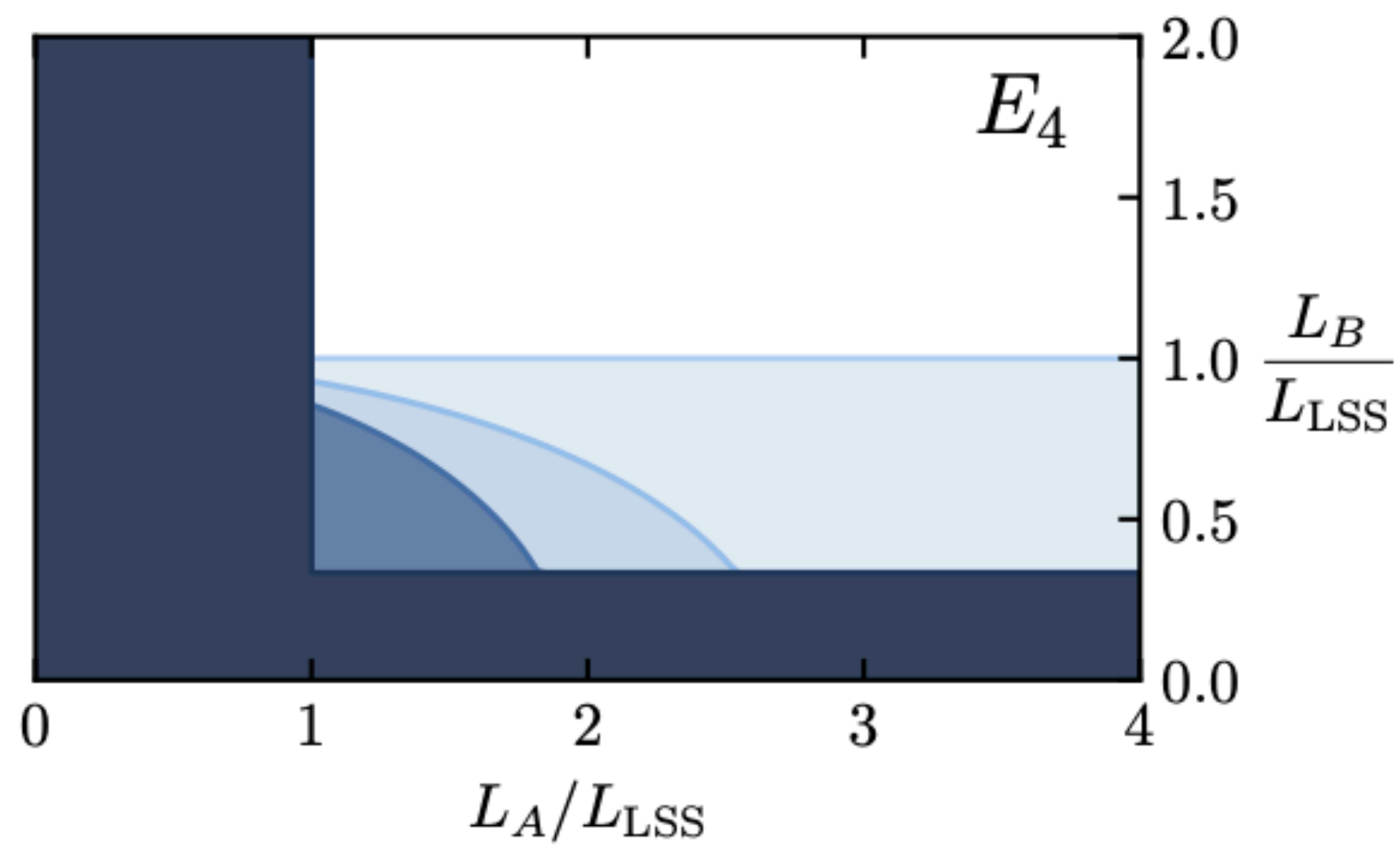
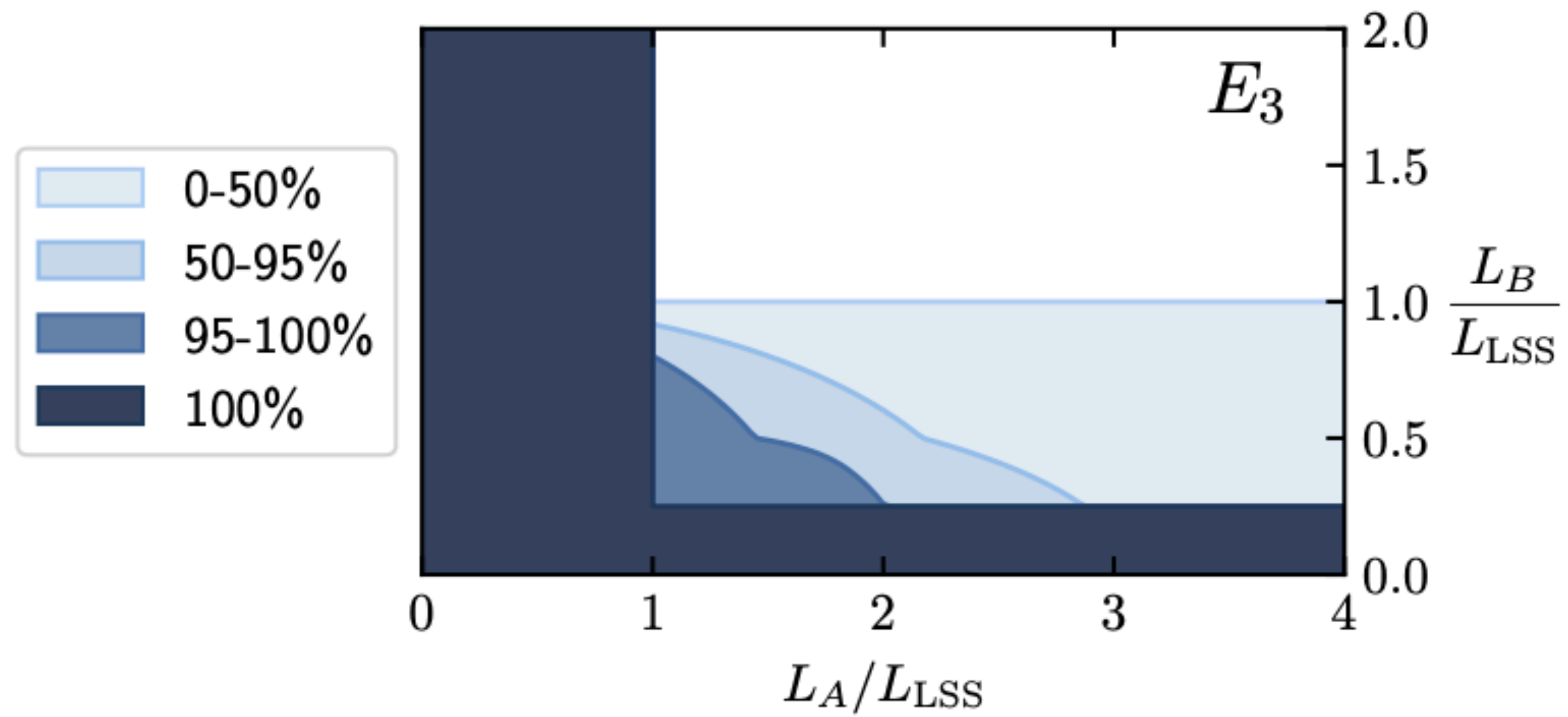

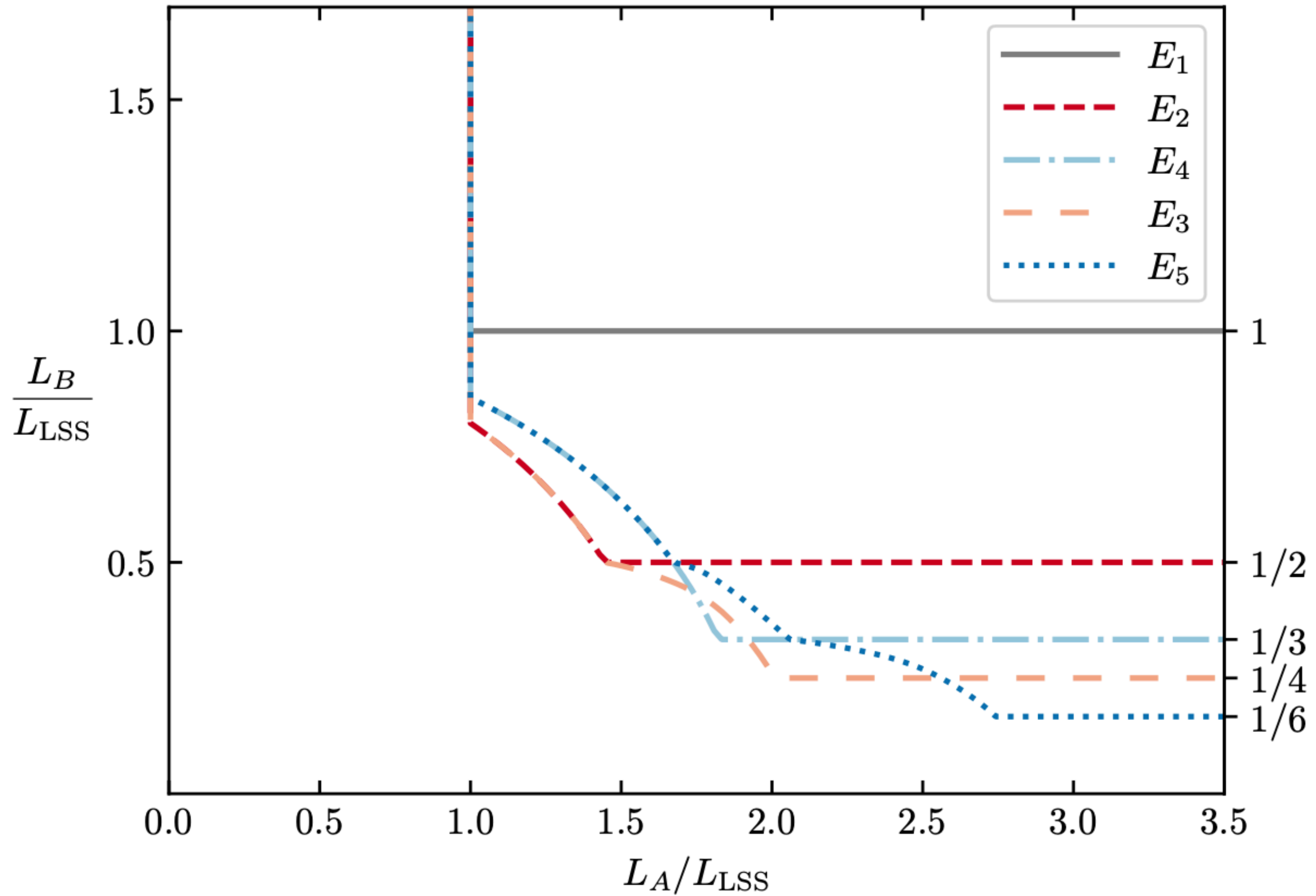

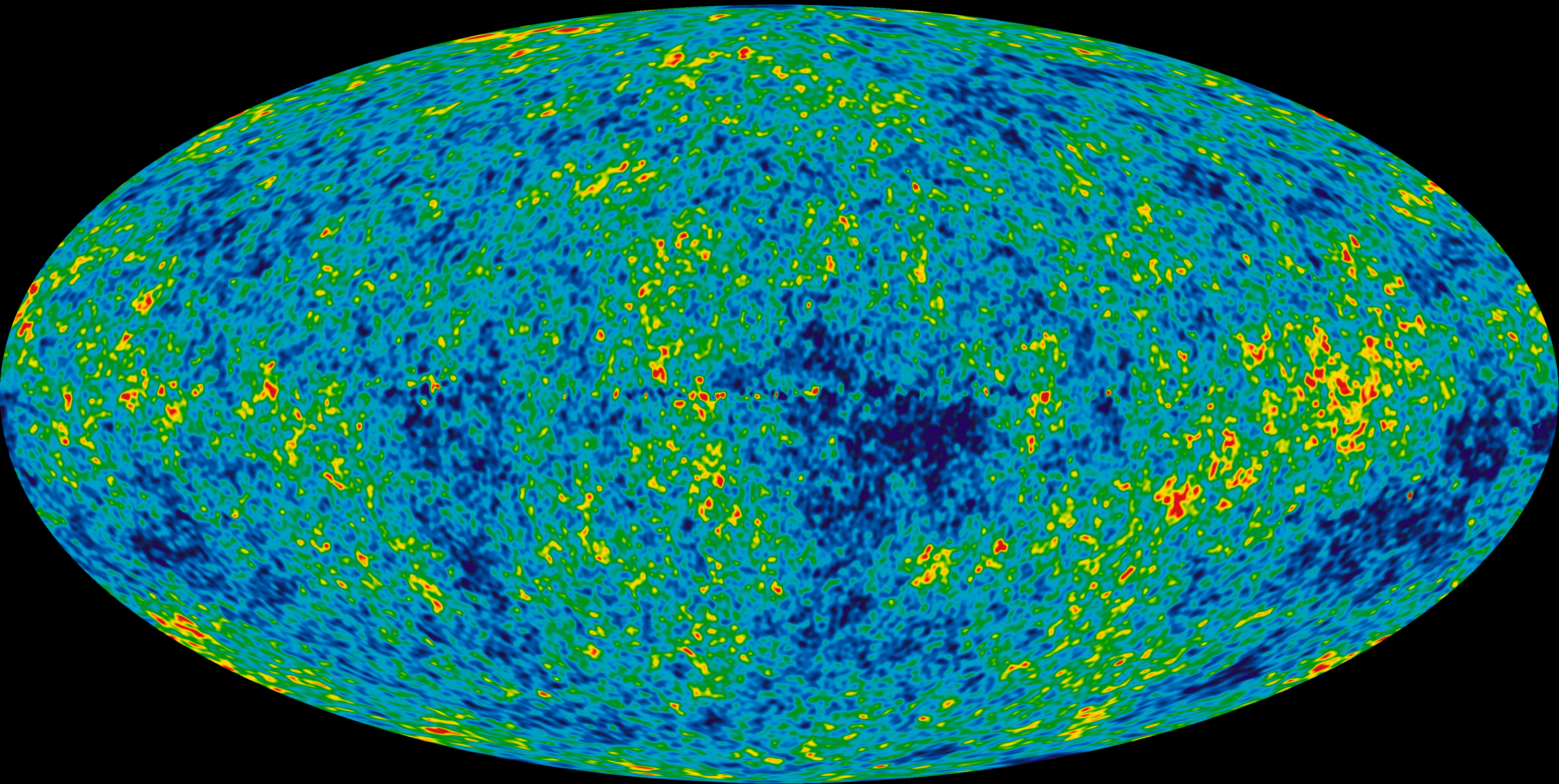

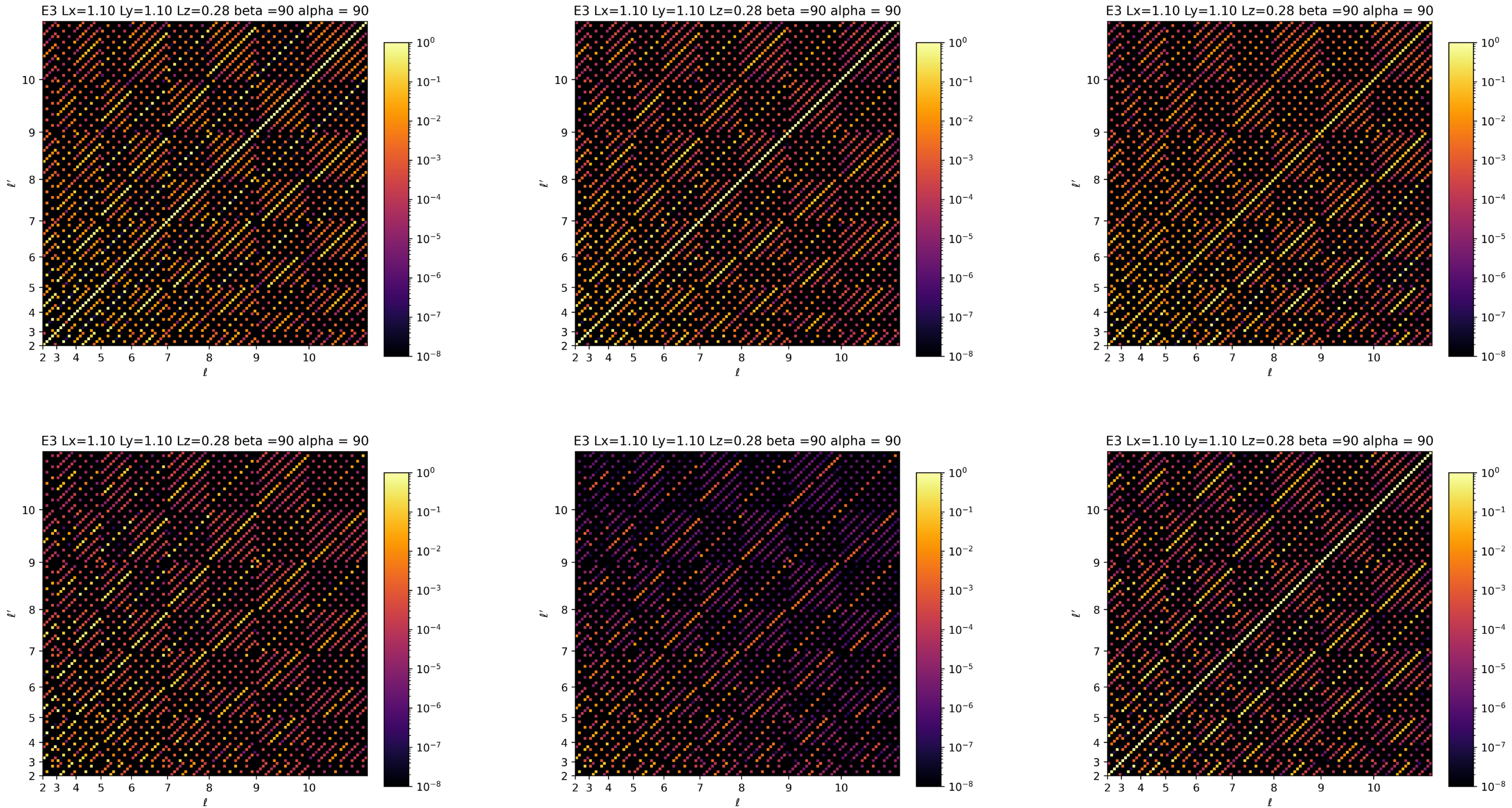

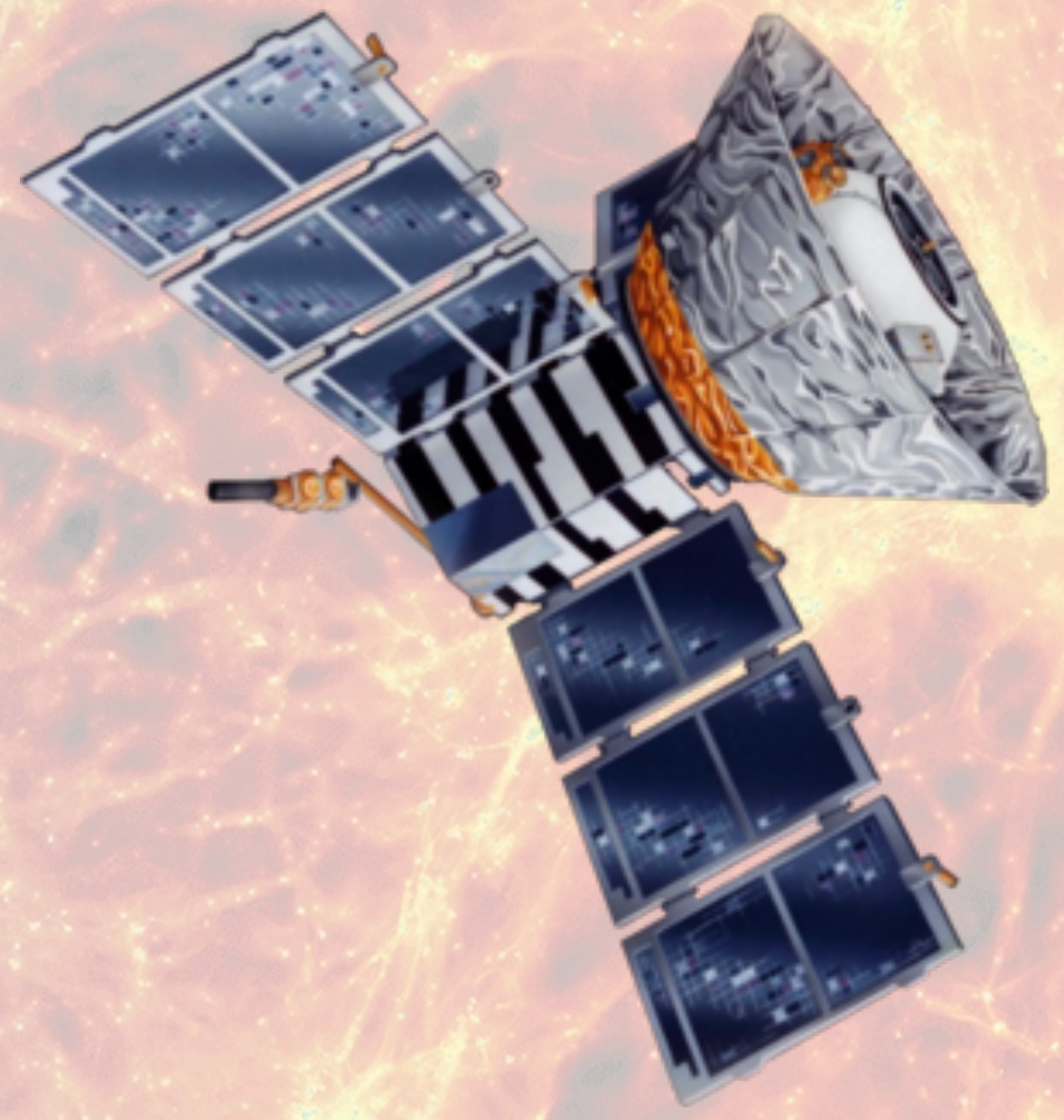
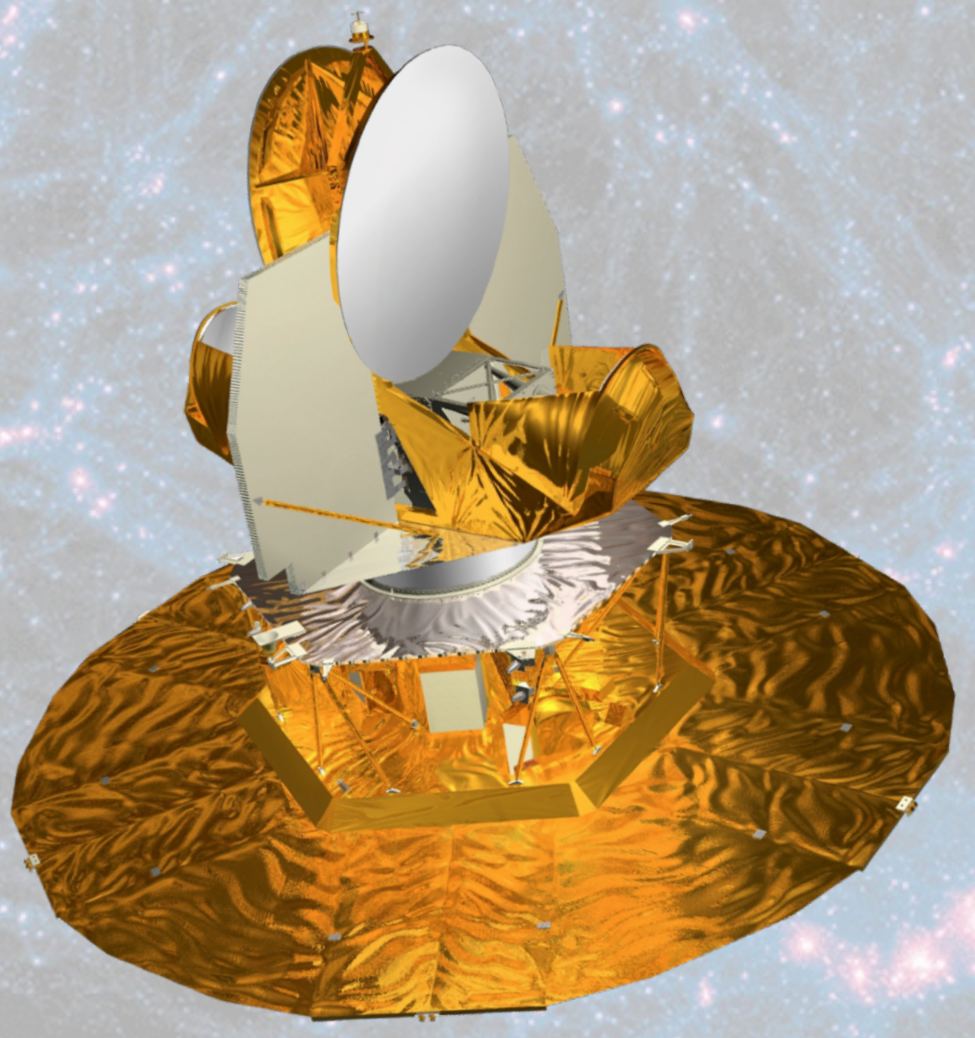

Summary

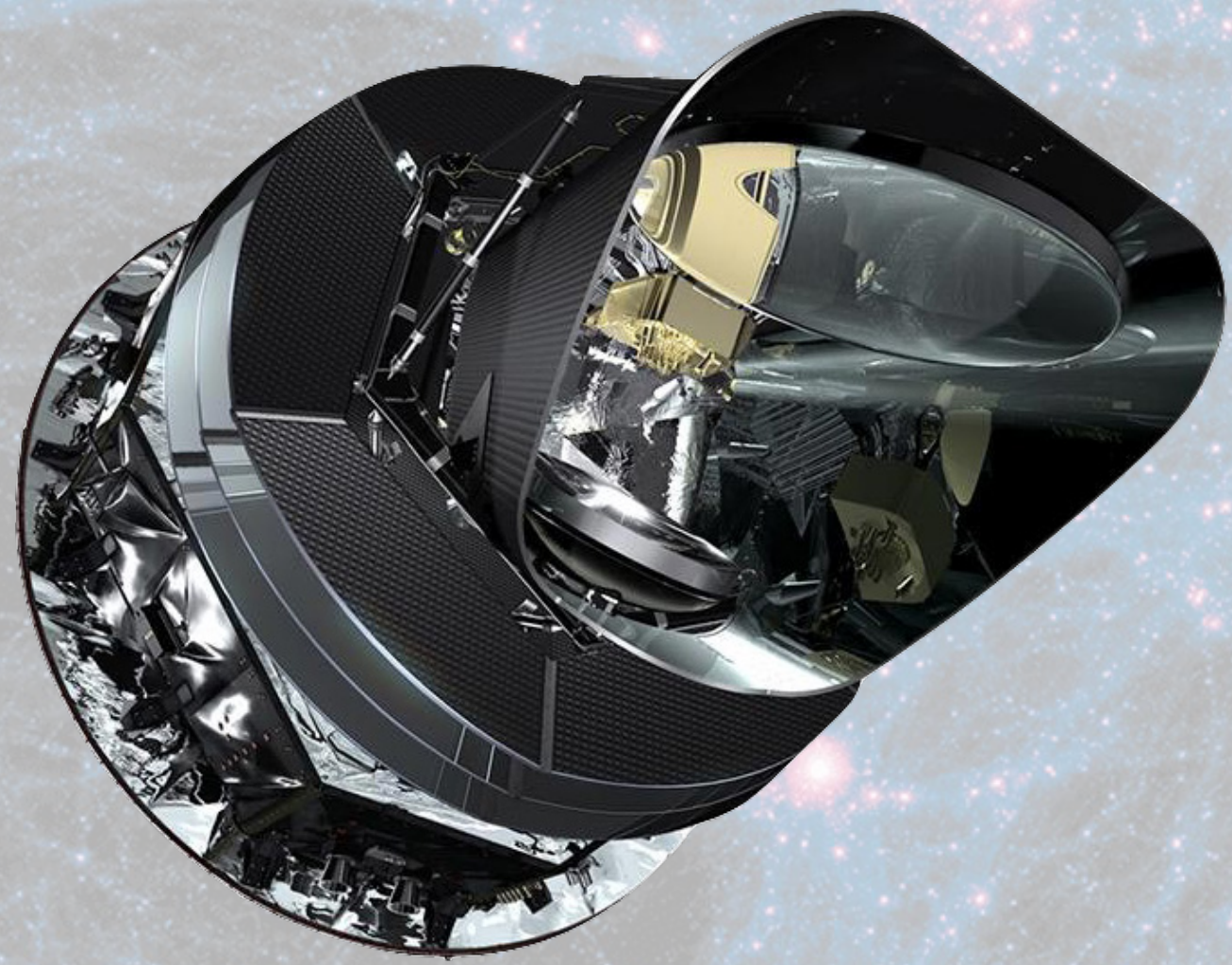

Ask me about

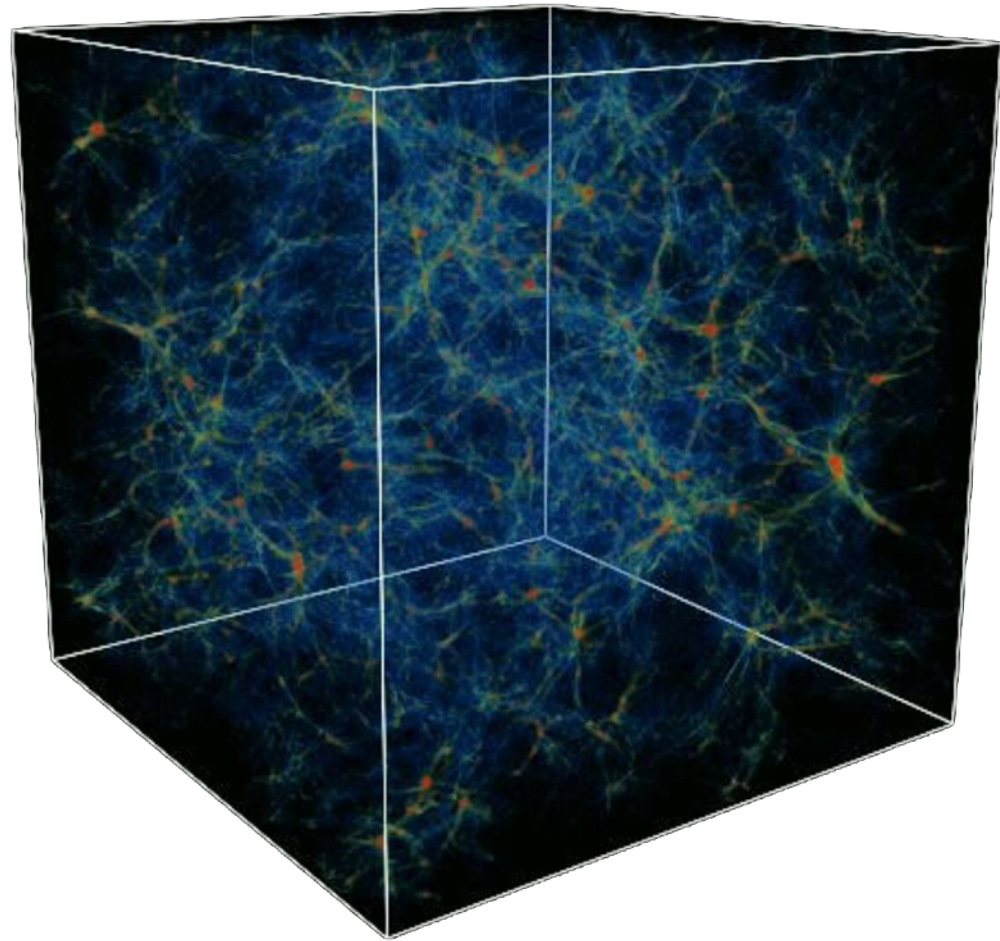

3D covariance
simulations

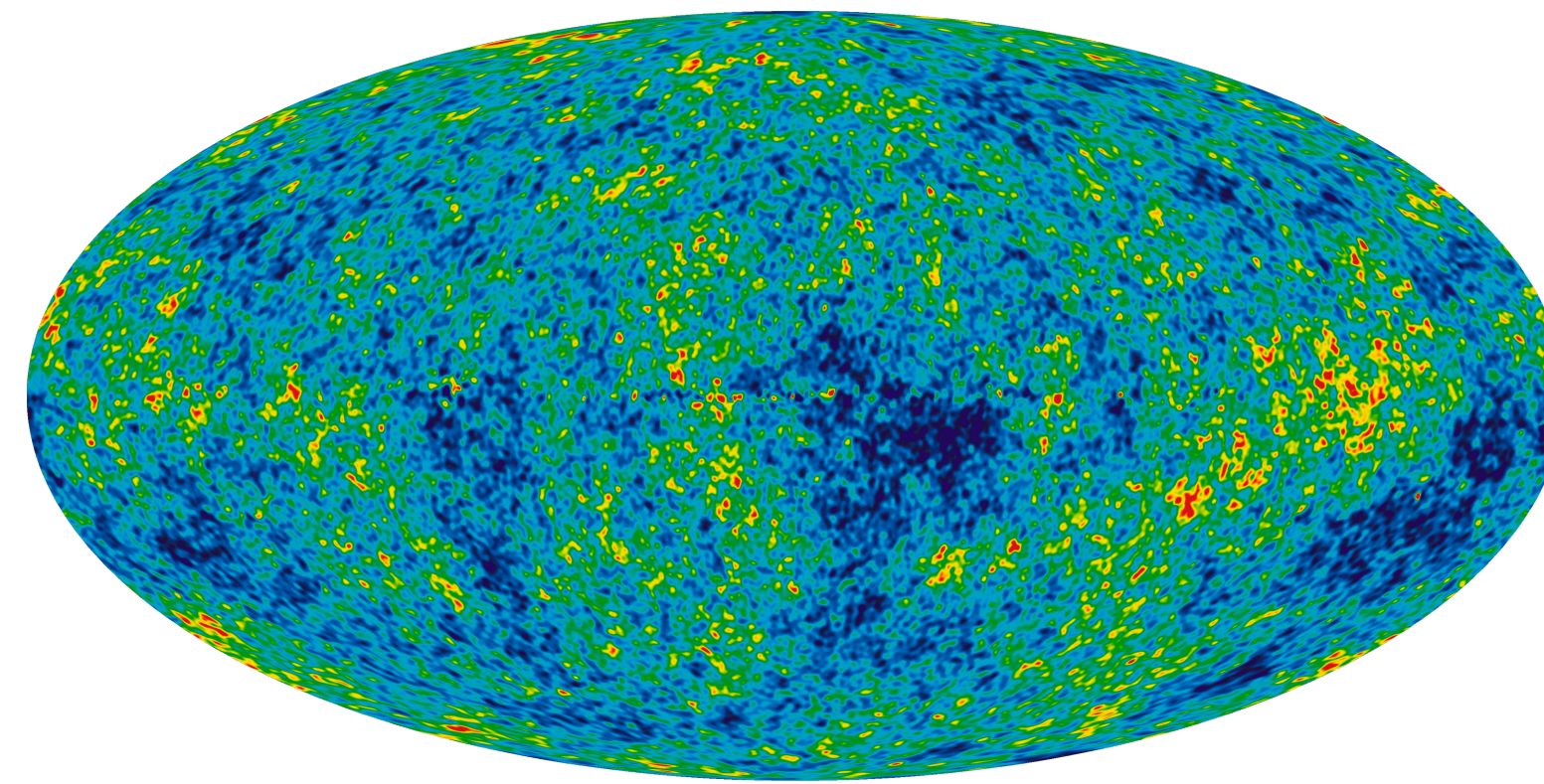

Circle searches in CMB surveys

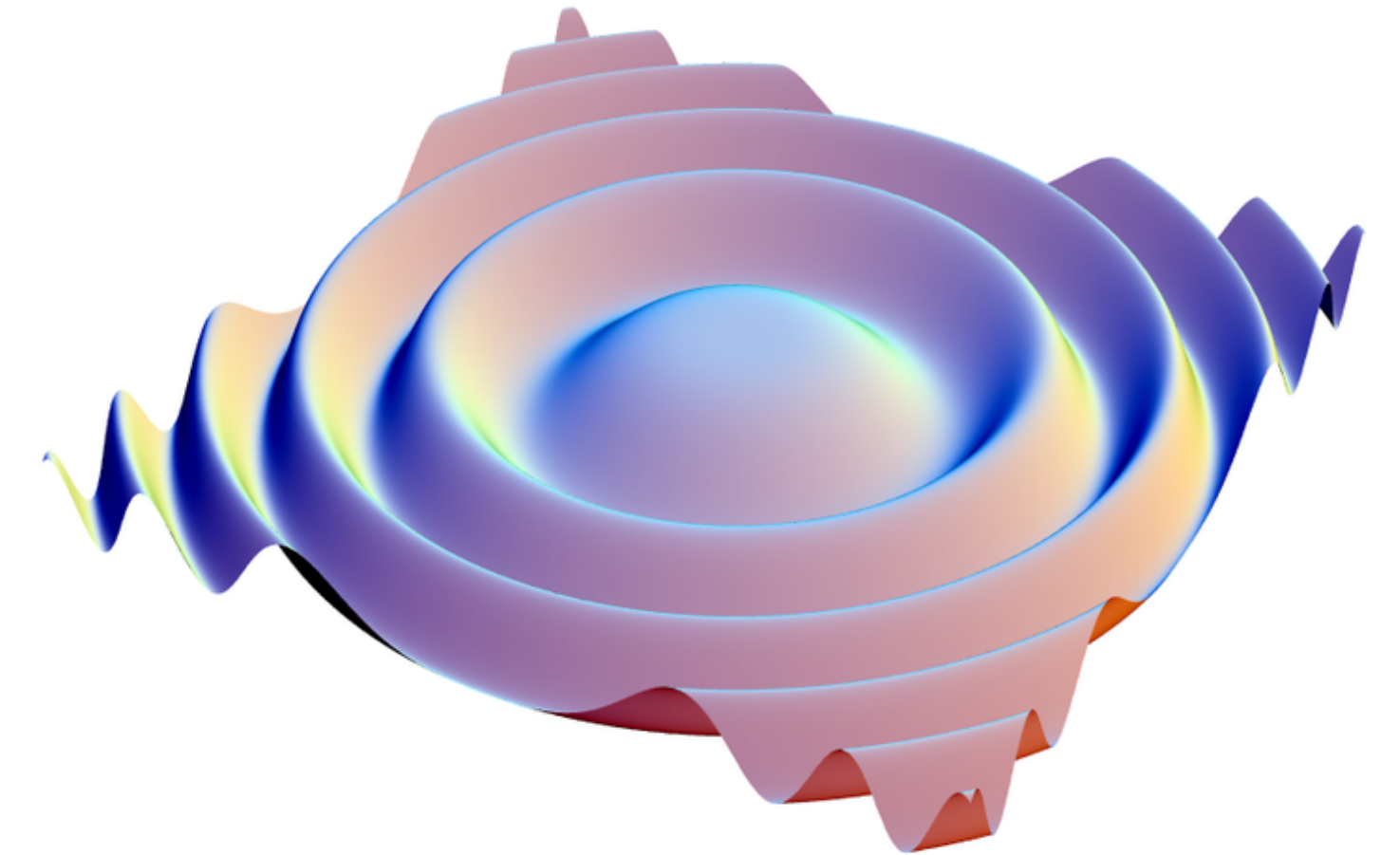

GWs in Euclidean topologies

Ask me about

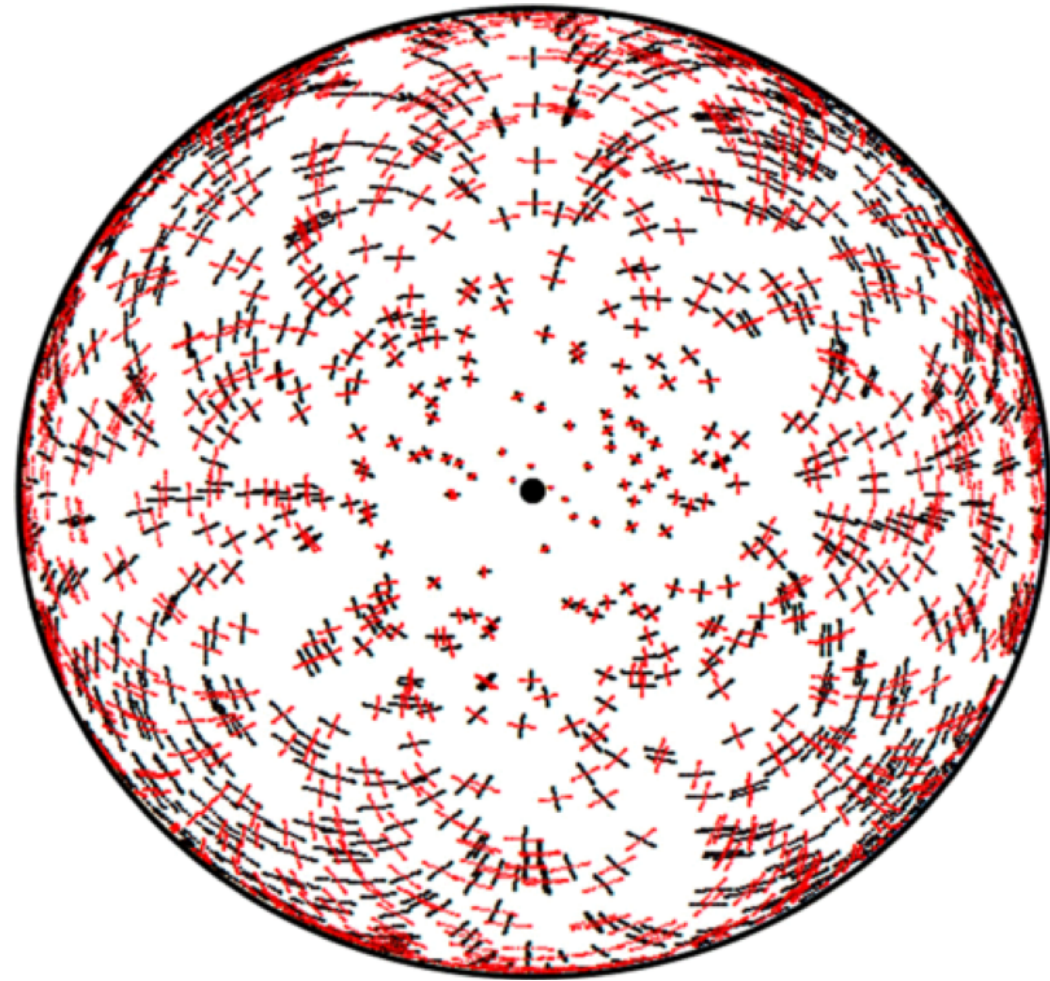

GWs and inflation
with Gaia data

$$H(p, q) \mapsto H(P, Q)$$

Canonical Perturbation
Theory for GR

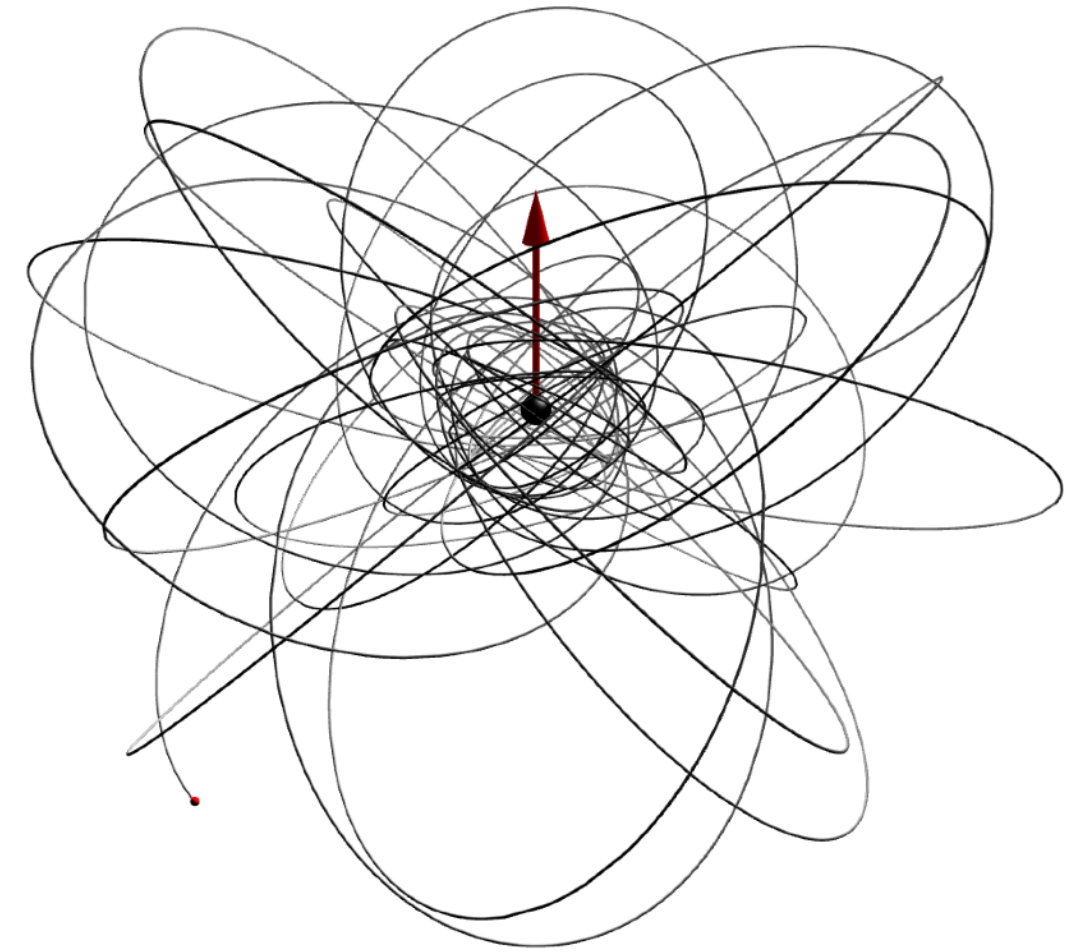

Self force and resonances in EMRIs



**CASE
WESTERN
RESERVE
UNIVERSITY**

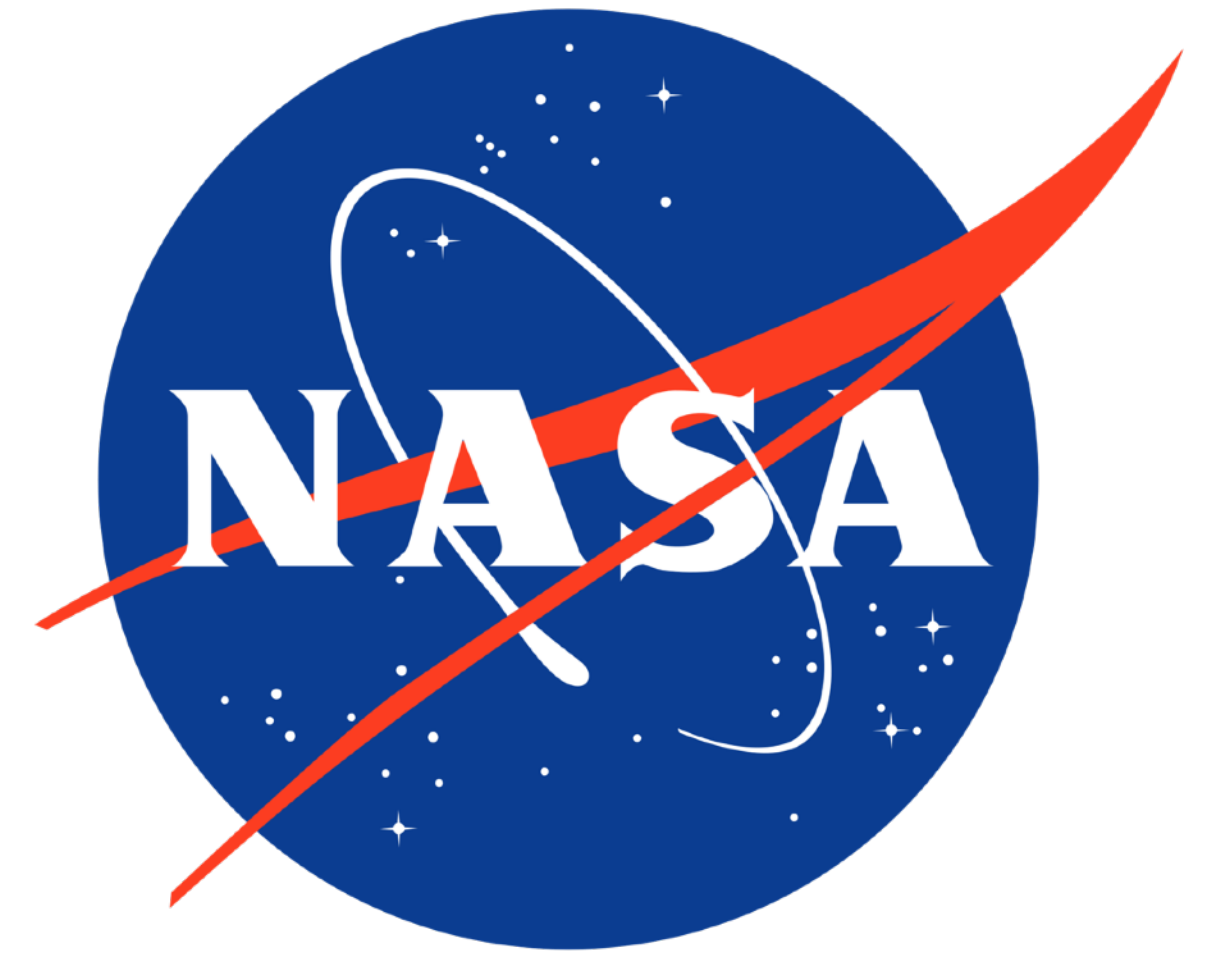

Questions?



**UNIVERSITY OF
CAMBRIDGE**